

DirecLink NE

Trailer Brake Controller

Installation and
Users Guide



Tuson RV Brakes, LLC
475 Bunker Court
Vernon Hills, IL 60061

www.direclink.com

May 2011

Contents

1	DirecLink Components.....	01
1.1	Inside the Box.....	01
2	Quick Start.....	02
2.1	About Quick Start.....	02
2.2	Quick Start Steps.....	02
3	Initial Connection and Test.....	03
3.1	About the Test.....	03
3.2	Electrical Connections.....	03
3.3	Connection Sequence.....	03
3.4	First Time Power-Up.....	04
4	Final Installation of Modules and Cables.....	05
4.1	Final Installation Sequence	05
4.2	Final Installation Sequence (continued).....	06
5	Setting Brake Scale - Initial Operation.....	07
5.1	Brake Scale (Home Page).....	07
5.2	Heavy Trailers.....	07
5.3	Confirm Trailer Connection.....	07
5.4	Road Test and Fine Tuning Brake Scale.....	07
5.5	DirecLink Sleep Mode.....	07
6	Manual Braking.....	08
6.1	Manual Braking.....	08
7	7.0 Screen and Button Functions.....	09
7.0	Screen and Button Functions, Continued.....	10
8	Main Menu Navigation and Settings.....	11
8.1	Main Menu Screens.....	11
8.2	Brake Scale (Home Screen).....	11
8.3	Low Speed Brake.....	11
8.4	Transmission Temp.....	12
9	Configure Option Menu.....	13
9.1	Configure Options.....	13
9.2	Controller, Keypad and Actuator Config Screens.....	13
9.3	Controller Config Menu Options.....	13
9.4	Trailer Size.....	14
9.5	Brake Level When Stopped.....	14
9.6	Max Brake Limit.....	15
9.7	Controller Reset.....	16
9.8	Keypad Config Menu Options.....	16
9.9	Screen Brightness Adjustment.....	17
9.10	Screen Sound Adjustment.....	17
9.11	Actuator Config Menu Options.....	17
9.12	Actuator Reset.....	18
9.13	Fluid Level Sensor.....	18
10	Monitor Options Menu.....	19
10.1	Monitor Options.....	19
10.2	Controller Data Screens.....	19
10.3	Vehicle Mode.....	19
10.4	Vehicle Battery and Brake Light Voltage.....	19
10.5	Controller Temp, Amps and Volts.....	19
10.6	MPH, KPH, Engine RPM.....	20
10.7	DirecLink BAUD.....	20
10.8	Actuator Data Screens.....	20
10.9	Motor Load.....	21
10.10	Vehicle Battery and Trailer Battery.....	21
10.11	Actuator Temperature.....	21
10.12	Actuator Fluid Level.....	22
10.13	Firmware Version.....	22
11	Faults Codes and Trouble Shooting.....	23
11.1	When Faults Are Detected.....	23
11.2	Fault Codes and Descriptions.....	23
11.3	Faults Viewer Screens.....	24
11.4	Select the Controller Fault Screen.....	24
11.5	Descriptions of Major Faults and Resolutions.....	25
11.5	Descriptions of Major Faults and Resolutions, Cont....	26
	Limited Lifetime Warranty.....	27

1 DirecLink NE Components



1.1 Inside the box

Control Module	#1
Command Module	#2
OBDII Cable	#3
Delphi Harness	#4
Spiral Cable	#5
Flush Dash Mount	#6
Swivel Dash Mount	#7
Alcohol wipe	not shown
5 Cable Ties	not shown
Users Manual	not shown

Read and Save This Manual

- Before beginning installation, read and become familiar with these instructions.
- Save this manual and store it in your tow vehicle for future reference.
- Improper installation and operation could cause serious or fatal injuries and/or property damage.

Please Note:

The DirecLink NE trailer brake controller works with 2 - 8 electric drum brakes and electric-hydraulic trailer brake actuators. It automatically detects which type you have and configures itself accordingly.

2 Quick Start

2.1 Quick Start

By following the steps outlined in sections 3-7 of this manual, you can install and use the basic features of the DirecLink NE trailer brake controller. However, we strongly encourage you to read and utilize the more advanced features of DirecLink NE which are outlined in sections 8-11 of this Installation and Users Guide.

2.2 Quick Start Steps

1. Initial Connections and Test
2. Final Installation of Modules and Cables
3. Setting Brake Scale
4. Manual Braking

3 Initial Connection and Test

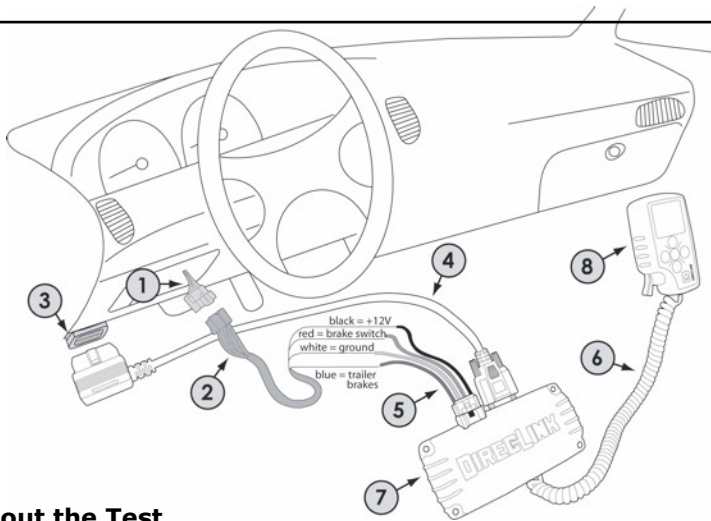

3.1 About the Test

The purpose for the initial test, prior to securing the cables and mounting the modules is to verify that the required wiring connections are available and functioning properly. By checking this functionality first, it is easier to make any repairs or corrections while all wiring and components are easily accessible.

3.2 Electrical Connections

The required electrical connections are indicated by the numbers in the diagram above:

1. Vehicle specific trailer wiring connector (already in vehicle or can be purchased)
2. Vehicle specific trailer wiring harness (must buy separately)
3. Vehicle OBDII connector (already in vehicle)
4. OBDII to DB9 Cable (included with DireLink NE)
5. Delphi 4 Wire Harness (included with DireLink NE)
6. Spiral Cable (included with DireLink NE)
7. DireLink NE Control Module
8. DireLink NE Command Module

3.3 Connection Sequence

With the vehicle ignition turned OFF and the trailer DISCONNECTED from the vehicle, make the wiring connections in the following order:

First: connect 2 with 5. If your vehicle is not equipped with a harness that plugs directly into the DireLink NE's Delphi connector, than you must use the Delphi 4 wire harness included in your package. The diagram above shows the functions of the four wires of the Delphi harness. These wires must be connected to the vehicle by function and NOT by color. The label attached to the Delphi harness contains common wire function and color for various vehicle manufacturers. If your vehicle is not listed on this label, consult your owner's manual to determine your vehicle's wiring function by color. Once you have determined the correct wire connections for the four wire harness, use a crimp-type connector to securely fasten the wires together.

Once you have finished securely connecting 2 with 5 as outlined above, complete the connection sequence as follows:

Second: connect 1 with 2
Third: connect 3 with 4
Fourth: connect 4 with 7

Fifth: connect 5 with 7
Sixth: connect 6 with 7*
Seventh: connect 6 with 8

* Use any of the 3 RJ connectors in item 7; select the connector that makes routing of the spiral cable to item 8 as easy as possible.

3 Initial Connection and Test

3.4 First Time Power-Up

3.4.1 After the electrical wires and cables have been installed per the previous section, the next step is to wake-up the DirecLink NE and verify correct operation. While viewing the Command Module display screen, start the vehicle and depress and release the brake pedal. It is not necessary to press any buttons since the following configuration process is fully automated. If all electrical connections are correct the display will turn on with a blue background and white text reading **"DirecLink"** as shown in (#1) below:

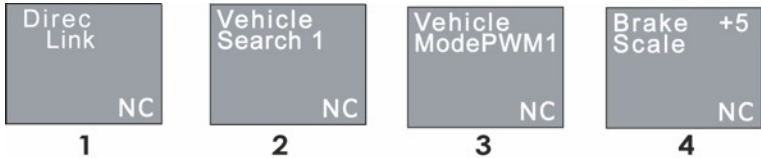

3.4.2 The **"VEHICLE SEARCH ___"** screen (#2) is displayed next. During this time the DirecLink NE is searching for the type of vehicle network that is connected. Once the network is found, screen (#3) **"VEHICLE MODE ___"** is displayed. In the (#3) example, PWM1 is shown. If PWM, VPW, CAN or ISO appear in this screen, that indicates a successful connection has been made with your vehicle. Once DirecLink NE connects, it automatically switches to the Brake Scale screen, #4 above.

Note: The **"VEHICLE SEARCH ___"** screen will continue to cycle through the various numbers and not proceed to the next screen if the following conditions exist:

1. The vehicle ignition is not turned to the "ON" position
2. The vehicle network is not supported by DirecLink NE (see list below)

SUPPORTED VEHICLE NETWORKS

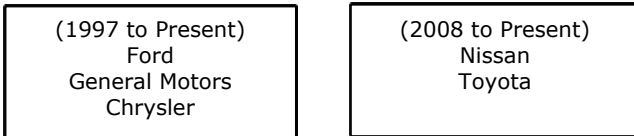

* Not all models with all years have been tested and verified to operate with the DirecLink NE, however significant sample testing has been performed spanning the range of vehicles in the supported vehicles networks (listed above) and indicate a wide compatibility with the manufacturers and years listed.

3.4.3 After the vehicle network connection is successfully completed, screen (#4) **"BRAKE SCALE ___"** is displayed. The appearance of this screen indicates that the DirecLink NE has successfully established communication with your vehicle and is now operational.

3.4.4 The red "NC" that appears in the lower right corner of the display indicates that the DirecLink NE is not connected to a trailer braking system. Once the trailer is connected to the vehicle and a braking system is detected, the red "NC" will turn to a green "C".

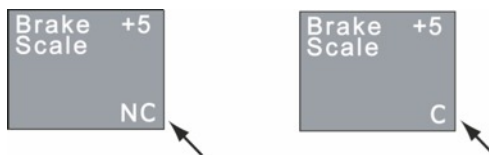

4 Final Installation of Modules and Cables

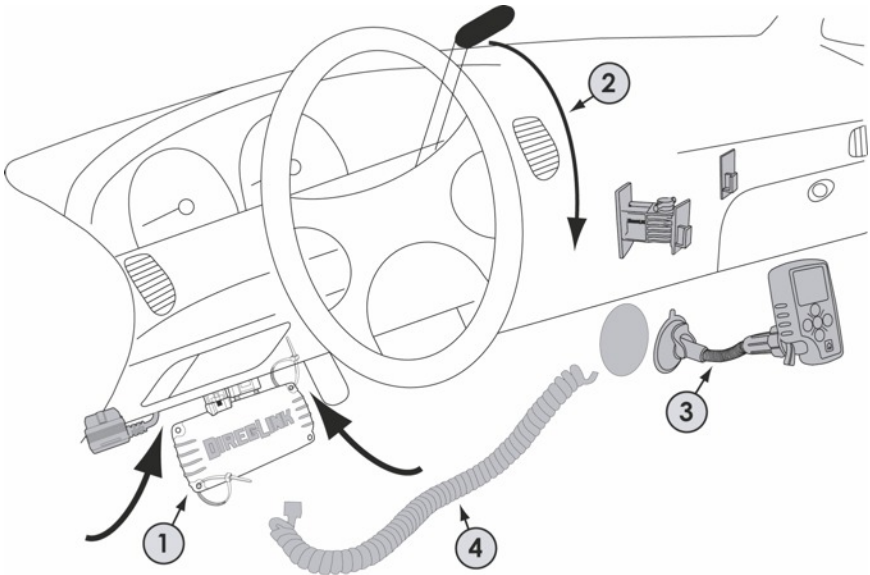

4.1 Final Installation Sequence

After successfully completing the initial connections and power-up described in section 3, perform the final installation in the following sequence:

1. Using the cable ties provided, secure the OBDII cable, Delphi harness and the control module up underneath the dash with the RJ connectors (phone style connectors) facing out toward the driver to make it easy to plug in the spiral cable. Route the cable ties through at least two of the four corner holes in the control module case and attach them to solid objects under the dash such as support brackets. Be sure all cables are securely fastened to prevent interference with the driver's feet. The control module can be mounted in any orientation without affecting operation.
2. Select the location to mount the command module. There are two different styles of dash mounts that are included with the DirecLink NE; flush mount and swivel mount. Both use a peel-off adhesive back for mounting. It is very important to clean the selected mounting surface with an alcohol wipe (included) and let the surface dry before attaching the mount. In selecting a good mounting location be especially aware of the gear shift lever. Make sure that the selected location does not interfere with the entire travel of the gear shift lever when shifting from park all the way down to low gear.
3. After the command module is mounted in an easily viewable and reachable location, attach the spiral cord to any of the three RJ connectors on the control module and connect it to the bottom of the command module.

4 Final Installation of Modules and Cables

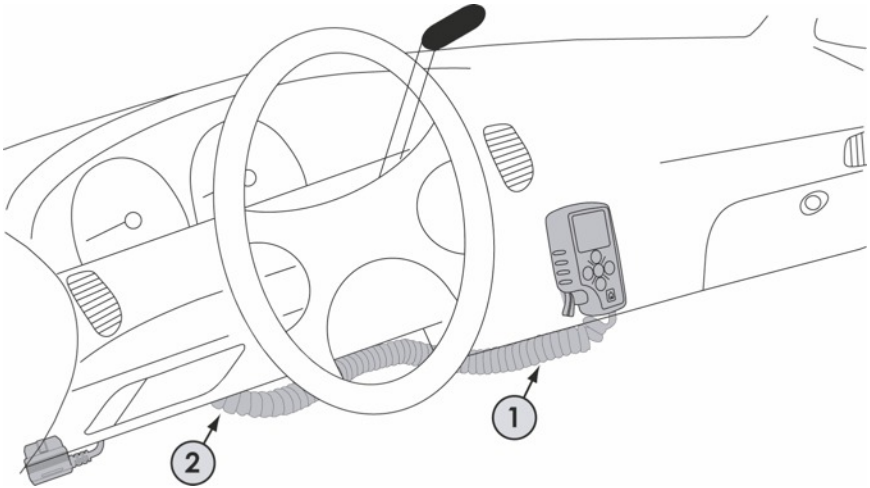

4.2 Final Installation Sequence

When the DirecLink NE is properly mounted, the only parts visible are the command module, spiral cable and possibly the OBDII connector (depending on the location of the connector in the vehicle).

1. The spiral cord should be routed to the control module in a manner that keeps the cord somewhat tight and against the dash to avoid interfering with the vehicle's moving parts or the driver's legs.
2. If needed, a cable tie can be used under the dash by the control module to take any excess slack out of the spiral cable. Do not make the spiral cable too tight and keep enough slack to be able to remove the command module from the mount and hold in your hand to operate the buttons.



Warning!

All wiring must be connected as instructed in this manual for the DirecLink NE to operate correctly. Failure to connect all the wires correctly may cause a loss of trailer brakes resulting in serious or fatal injury and/or property damage.



Warning!

The white wire of the Delphi connector (connector #5 in the diagram on page 3) must be connected to the negative terminal of the tow vehicle battery. Improper ground will result in the loss of trailer brakes which may result in serious or fatal injuries and/or property damage.



Warning!

DO NOT connect the black wire of the Delphi connector (connector #5 in the diagram on page 3) to any vehicle power supply line or fuse panel that could cause circuit overload or damage to tow vehicle wiring and vehicle electronics.

5 Setting Brake Scale - Initial Operation



5.1 Brake Scale (Home Screen)

The HOME screen for the DirecLink NE is the **Brake Scale** screen. This is the first screen in the main menu and it appears upon completion of a successful power-up or when the **HOME**  button is pressed.



The **Brake Scale** number represents the level of trailer braking that the DirecLink NE will apply to the trailer brakes when the tow-vehicle brakes are applied. The value can be adjusted from +1 to +20 with +1 being very light braking and +20 being very heavy braking. (The default level is set at +3.)

To adjust the Brake Scale:

1. Press the **Up** or **Down**  /  arrows on the keypad and this will immediately raise or lower the Brake Scale level. THERE IS NO NEED TO PRESS ENTER. The level of Brake Scale can be changed at any time.

5.2 Heavy Trailers

If your trailer weighs more than 10,000 lbs., you should configure the DirecLink NE to LARGE trailer as explained in section 9 of this guide. This increases the Brake Scale levels from +1 to +40 providing you with 40 levels of Brake Scale giving you greater flexibility in finding the optimal braking level for your larger trailer. **SEE SECTION 9.**

5.3 Confirm Trailer Connection

Now that the DirecLink NE has successfully powered-up and after properly hitching the trailer to the tow vehicle, you can verify the trailer's electrical connection. If the DirecLink NE has properly detected the trailer brake system, a green "C" or a green "DL" (see feature 9 on page 10 for more information) will appear in the lower right hand corner of the display screen. If a red "NC" appears in the lower right hand corner of the display screen after the trailer's electrical plug has been attached to the tow vehicle's receptacle, see page 25 of this manual in the Faults and Trouble Shooting section, and do NOT tow the trailer.

5.4 Road Test and Fine Tuning Brake Scale

Once you have a green "C" or "DL" in your display screen and the trailer is properly hitched to the tow vehicle, you are ready to make some slow speed stops to verify the correct level of Brake Scale.

Position the tow vehicle and trailer in a low traffic area on a hard, flat, dry surface and follow these steps:

1. Accelerate to approximately 25 miles per hour and make a normal stop. The trailer brakes should provide firm braking without the trailer tires locking. Inversely, the trailer should not push against the tow vehicle during braking.
2. If the trailer tires lock, reduce the Brake Scale until this is resolved. If the trailer pushes the tow vehicle raise the Brake Scale until this problem is resolved.
3. Once you are confident of the Brake Scale level, make several stops at 50 miles per hour and confirm the level of Brake Scale or re-adjust as needed.

5.5 DirecLink NE Sleep Mode

Once the vehicle's engine is turned off, the DirecLink NE will go into "sleep mode" after 5 minutes causing the Command Module screen to turn off. Once the DirecLink NE enters "sleep mode" the brake pedal must be depressed to resume operation. The 5 minute "sleep mode" can be delayed if any button or the trigger on the Command Module is activated, or if the brake pedal is pushed while the engine is turned off.

6 Manual Braking

6.1 Manual Braking

The DirecLink NE is equipped with a “trigger” that provides the driver the ability to manually apply the trailer brakes from 1 to 100% braking force. As the trigger is pulled a bar appears from left to right on the display with a numerical percentage corresponding to the amount of manual braking being applied. When the trigger is released, the trailer brakes are released and the bar disappears from the display.

Trailer braking during manual operation using the trigger does NOT use the Brake Scale settings. The percentage braking force displayed is the percentage of braking force of the trailer brake system. Keep this in mind as you use the manual over-ride trigger as it is possible that you will lock your tires if you apply very high levels of manual braking.



Warning!

Manual brake operation using the trigger manual over-ride may not disengage the Cruise Control on some vehicles.



Warning!

Trailer brake lock-up may cause a loss of control of the trailer and/or the tow vehicle. This may cause serious or fatal injuries and/or property damage. Take care in applying trailer brakes in manual operation and always set your Brake Scale so the trailer tires do NOT lock up during braking.

This concludes the Quick Start.

You are ready to use the basic functions of the DirecLink NE.

The DirecLink NE can be very precisely adjusted, it has more functionality and diagnostic capability. To learn more about these features, read the remainder of this manual. You will get more from your DirecLink NE trailer brake controller and have a much better understanding of how it works.

7 Screen and Button Functions

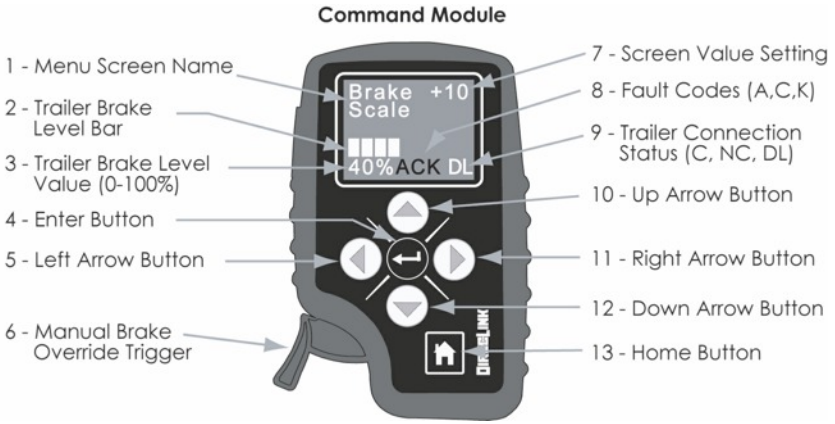

Feature	Description
1- Menu Screen Name	This area of the screen displays the title of the screen you are viewing.
2- Trailer Brake Level Bar	This moving bar indicates the level of trailer braking signal being sent from the DirecLink NE to the trailer from 0 to 100%. When using the manual trigger, the bar is white in color; under normal braking using the vehicle brake pedal, the bar is yellow in color; and if network communication is lost the bar is red in color.
3-Trailer Brake Level Value	This numeric value corresponds with the Trailer Brake Level Bar and also indicates the level of trailer braking signal being sent from the controller to the trailer (from 0 to 100%).
4-Enter Button	This button is used to accept a value or selection on the menu screen. Pressing the enter button communicates this selected value to the DirecLink NE.
5-Left Arrow Button	The left arrow button is used to navigate in reverse direction through the Main Menu screens. It is also used to navigate to the upper menu levels when in the configure and diagnostics screens.
6-Manual Brake Override Trigger	The manual brake override trigger allows the operator to manually apply from 0 to 100% of the trailer brakes by sliding the spring-loaded trigger into the housing. Releasing the trigger also releases the trailer brakes.
7-Screen Value Setting	The screen value setting indicates the accepted and/or current value that is set for the menu screen being displayed. In the example above, the Brake Scale is set to +10. Other menu screens have text values like OFF/ON and others have percentage values that can be changed.

7 Screen and Button Functions

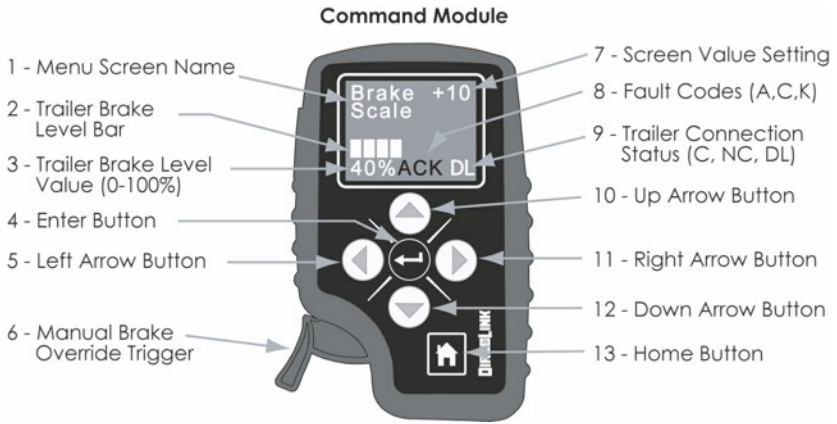

Feature	Description
8 - Fault Codes	The fault code section of the display is used to alert the driver of device operational problems many of which can cause the trailer braking system to not function at all or at a reduced performance level. The three letter designators indicate the device in the braking system that is experiencing a fault: A = the ActuLink Actuator (mounted on the trailer) C = the Controller (DireLink) K = the Keypad (DireLink)
9 - Trailer Connection Status	The trailer connection status indicates the DireLink NE's communication status with the trailer braking components located on the trailer. The three designations are: DL = Connected to the ActuLink Actuator (using two-way, 8 bit data network) NC = Not Connected C = Connected (using conventional PWM braking signal)
10 - Up Arrow Button	The up arrow button is used to increase a data value for adjustment and is also used to scroll up in certain menus. In the configure and diagnostics screens, the up arrow is used to scroll through the selections at the current menu level.
11 - Right Arrow Button	The right arrow button is used to navigate in the forward direction through the Main Menu screens. It is also used to navigate to the upper menu levels when in the configure and diagnostics screens.
12 - Down Arrow Button	The down arrow button is used to decrease a data value for adjustment and is also used to scroll down in certain menus. In the configure and diagnostic screens, the down arrow is used to scroll through the selections at the current menu level.
13 - Home Button	The home button is used for returning to the Brake Scale main menu screen.

8 Main Menu Navigation and Settings

8.1 Main Menu Screens

There are three (3) screens that comprise the main menu of the DirecLink NE, they are:



8.2 Brake Scale (Home Screen)

This screen is covered in section 5 of this manual.



8.3 Low Speed Brake

The **Low Speed Brake** screen is accessed by pressing the **RIGHT ARROW**  button when on the **Brake Scale** screen.



The **Low Speed Brake** value allows the driver to adjust the amount of braking that the DirecLink NE applies at low vehicle velocities such as in town driving. The selectable values go from -5 to +5. The **-5** value is the **most reduction** that can be made to the low velocity brake level and the **+5** is the **most additional** braking that can be adjusted to the low velocity brake level for a given **Brake Scale** setting. A Low Speed Brake setting of **0** will **not change** the low velocity brake levels of the **Brake Scale** setting.

In order to adjust the **Low Speed Brake** settings:

1. Press the **ENTER**  button when on the **Low Speed Brake** screen and a number will appear on the line underneath the current setting.
2. Press the **Up** or **Down**  arrow button to change the bottom setting to the desired setting (from -5 to +5).
3. Set the lower number to your desired value and press the **ENTER**  button.
4. The top line will change to your new selected number.

Note: If you press the left arrow, right arrow or home buttons before pressing the **ENTER** button, the new **Low Speed Brake** setting will NOT be saved before moving to the next screen.

The need for a **Low Speed Brake** adjustment results from the different configurations, sizes and conditions of trailer braking systems. To determine the best **Brake Scale** and Low Speed Brake settings for your tow vehicle-trailer combination, leave the **Low Speed Brake** setting at 0 and adjust **Brake Scale** setting to the desired amount of trailer braking at 50 mph. As you reach the desired **Brake Scale** setting, when your vehicle velocity is under 30 mph, if the braking is too aggressive, adjust the **Low Speed Brake** setting to -1, -2, etc. Each negative increment will decrease the aggressiveness of braking under 30 mph. If the braking is not aggressive enough under 30 mph, adjust the **Low Speed Brake** setting to +1, +2, etc. This will increase the aggressiveness of the brake levels under 30 mph. As you decrease or increase the **Low Speed Brake** settings, it may be necessary to decrease or increase the **Brake Scale** settings in order to find the ideal match of the two settings for your tow vehicle-trailer combination.

8 Main Menu Navigation and Settings

8.4 Trans Temp

The **Trans Temp** screen is accessed by pressing the **RIGHT ARROW**  button from the **Low Speed Brake** screen. The transmission fluid temperature is displayed in degrees Fahrenheit (F). This screen enables the driver to monitor the transmission for possible over-heating while pulling heavy loads in hot weather or up steep grades. Consult your vehicle's owners manual for the normal operating temperature of your transmission.



The **Trans Temp** screen will only appear on certain Ford and General Motor vehicles where DirecLink NE can access the transmission data on the tow vehicle network. On vehicles where DirecLink NE cannot access the transmission data, the **Trans Temp** screen will not appear or will display N/A if not available. In these cases the only operational main menu screens will be the **Brake Scale** and **Low Speed Brake** screens.

9 Configure Option Menu

9.1 Configure Options

The purpose of the **Configure Options** menu is to allow the driver to enable some additional features of the DireLink NE or re-adjust existing settings. The additional features contained in the **Configure Options** menu are turned OFF by default. Once turned ON by the driver, they remain ON until turned OFF.

To access the **Configure Options** menu, from the main menu:

1. Press and hold the HOME  button for 5 seconds.
2. After 5 seconds, the **Configure Options** screen will appear.



9.2 Configuration Screens

Under the Configure Options screen, there are three (3) sub menus: Controller Config, Keypad Config and Actuator Config. These sub menus allow you to adjust various settings of the DireLink NE as outlined in the sections below.

To access the Configuration screens from the Configure Options screen:

1. Press the **ENTER**  button and the Controller Configuration screen will appear.

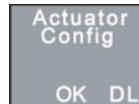
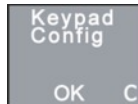

If DireLink is turned "ON" in Section 9.3

Pressing the up or down arrows will switch between these screens.

9.3 Controller Config Menu Options

The purpose of the Controller Config menu is to enable additional DireLink NE features that could assist in achieving the best brake controller performance for their specific tow vehicle-trailer configuration. To access the screens of the Controller Config menu:

1. Select the Controller Config Menu screen as outlined above.
2. Press the **ENTER**  button and the first of the Controller Menu screens will appear: Tralr Size.

There are five (5) screens that comprise the **Controller Config** menu, they are:

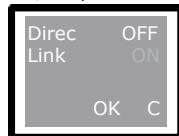
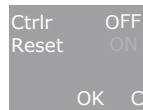
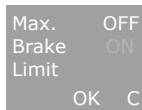
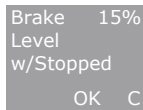
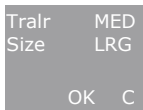

Pressing the up or down arrows will switch between these screens.

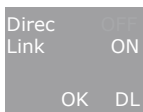

When DireLink NE is turned "ON", the green "C" indicator in the lower right corner will turn to a green "DL" once the Controller has established communications with the ActLink actuator. If the trailer is disconnected from the vehicle, the red "NC" will appear.





9 Configure Option Menu

9.4 Trailer Size



The **Trailer Size** screen allows the driver to select between **MED** (medium) and **LRG** (large) trailer sizes. The default setting is **MED**. The **MED** setting is a scaling factor that is applied to the **Brake Scale** setting. The **MED** setting is designed for trailers weighing up to 10,000 lbs. The **LRG** setting is designed for trailers that exceed 10,000 lbs. By having these two trailer size settings and having 20 levels of **Brake Scale** for each setting, that gives the driver 40 levels of **Brake Scale** to choose from in order to find the ideal trailer brake setting. Depending on the condition or configuration of your trailer's brake system, and regardless of its actual weight, you may select either the **MED** or **LRG** trailer setting to achieve optimal trailer braking performance. The DirecLink NE will operate properly in either **Trailer Size** setting regardless of the trailer size so do not hesitate to select the setting that provides your preferred level of trailer braking.

In order to switch between MED and LRG trailer settings:

1. Press the **ENTER**  button when on the **Trailer Size** screen.
2. Either **MED** or **LRG** will appear underneath the current setting.
3. Use the **Up** or **Down**  /  arrow to toggle between **MED** and **LRG** on the lower line.
4. Set the lower line to your desired selection and press the **ENTER**  button.
5. The top line will change to your new selection.





NOTE: If you press the left or right arrows before pressing **ENTER** to accept your new selection, your new selection will NOT be saved before changing to a different menu screen.

9.5 Brake Level When Stopped



The Brake Level w/Stopped screen allows the driver to set a desired percentage level of trailer brakes to be applied when the tow vehicle-trailer is at a stop. The level can be set from 5% to 30%. When activated, the DirecLink NE adjusts the trailer brakes up to the setting when tow vehicle-trailer velocity is zero. This feature is helpful when stopping on steep grades or on slippery boat ramps. By having the trailer brakes applied when stopped it helps keep the tow vehicle and trailer stationary.

In order to set the Brake Level w/Stopped value:

1. Press the **ENTER**  button when on the Brake Level w/Stopped screen.
2. A number will appear underneath the current setting.
3. Press the **Up** or **Down**  /  arrow to increment the value of the lower line up or down.
4. Set the lower line to your desired value and press the **ENTER**  button.
5. The top line will change to your new selection.

NOTE: If you press the left or right arrows before pressing **ENTER** to accept your new selection, your new selection will NOT be saved before changing to a different menu screen.

After setting the Brake Level w/Stopped value to something other than zero (0), you will notice that the Brake Bar on the screen will indicate the value you set when the tow vehicle-trailer comes to a stop.

9 Configure Option Menu

9.6 Max. Brake Limit



**ADDED TO THE
MAIN MENU
SEQUENCE**

The Max. Brake Limit screen is where the driver can turn ON or OFF the Max. Brake Limit function. The Max. Brake Limit function operates as a maximum brake level limit on the DirecLink NE output to the trailer brakes. If the Max. Brake Limit feature is turned ON, then an additional screen is added to the Main Menu sequence for the Max. Brake Limit.

In order to turn ON the Max. Brake Limit function:

1. Press the **ENTER** (↵) button when on the Max. Brake Limit screen.
2. An **ON** or **OFF** will appear underneath the current setting.
3. Press the **Up** or **Down** (▲/▼) arrow to toggle between ON and OFF.
4. Set the lower line to your desired selection and press the **ENTER** (↵) button.
5. The top line will change to your new selection.

Note: If you press the left or right arrows before pressing **ENTER** to accept your new selection, your new selection will NOT be saved before changing to a different menu screen.

The **Max. Brake Limit** adjustment enables the driver to set the maximum trailer braking level just prior to trailer tire lock-up. For example, if a trailer starts to skid one or more tires at a level of 75% controller output, the **Max. Brake Limit** can be set to 70% and that will limit the automatic braking level of the DirecLink NE to 70%. All other brake scaling features operate as normal with the maximum auto braking limiting at 70%. However, the manual over-ride will always provide 100% trailer brake output when the trigger is pulled completely in, even when **Max. Brake Limit** is turned **ON**.

Once the **Max. Brake Limit** feature is turned ON as described earlier, the **Max. Brake Limit (% adjustment)** screen appears in the Main Menu sequence. To access the **Max. Brake Limit (% adjustment)** screen:

1. Press the **RIGHT ARROW** (▶) key **TWO** (2) times from the **Brake Scale** (HOME) screen.

To change the value of the **Max. Brake Limit (% adjustment)**:

1. Press the **ENTER** (↵) button and a number will appear underneath the current setting.
2. Press the **Up** or **Down** (▲/▼) arrow to increment the lower number up or down.
3. Set the lower number to your desired value and press the **ENTER** (↵) button.
4. The top line will change to your new selected number.

Note: If you press the left or right arrows before pressing **ENTER** to accept your new selection, your new selection will NOT be saved before changing to a different menu screen.





9 Configure Option Menu

9.7 Controller Reset



The **Controller Reset** screen is where the driver can return all DireLink NE controller settings to the original manufacturer's defaults. This is helpful if the driver wants to reset and re-adjust the setting from the defaults that were in place when the DireLink NE was first installed into the vehicle.

In order to activate the **Controller Reset**:

1. Press the **ENTER**  button when on the **Controller Reset** screen.
2. An **ON** or **OFF** will appear underneath the current setting.
3. Press the **Up** or **Down**  /  arrow to toggle between **ON** and **OFF**.
4. Set the lower line to your desired selection and press the **ENTER**  button.
5. The top line will change to your new selection.



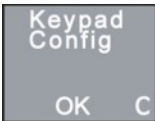

Note: If you press the left or right arrows before pressing **ENTER** to accept your new selection, your new selection will NOT be saved before changing to a different menu screen.

When **ON** is selected in the **Controller Reset** screen and the **ENTER** button is pressed, the screen will go to black and DireLink NE will re-start from the Vehicle Discovery process during which time all factory default settings will be restored. This means that any previously saved **Brake Scale** settings; **Low Speed Brake** settings and others will be lost and will need to be setup again.

9.8 Keypad Config Menu Options



The purpose of the Keypad Config menu is to adjust various settings of the DireLink NE as outlined below. To access the screens of the Keypad Config menu from the Configure Options menu:

1. Press the **ENTER**  button and the Controller Config screen will appear.
2. Press the **Up** or **Down**  /  arrow and the Keypad Config screen will appear.
3. Press the **ENTER**  button and the first of Keypad Config screens will appear: Scrn Bright.

There are two (2) screens that comprise the **Keypad Config** menu, they are:

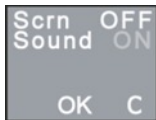





Pressing the up or down arrows will switch between these screens.

9 Configure Option Menu

9.9 Screen Brightness Adjustment





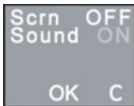

The Scrn Bright screen is used to adjust the brightness of the color display of the command module. There are three (3) settings which can be selected: 1) Hi, 2) Med, 3) Lo. Under various lighting conditions, you may wish to adjust the brightness of the display. To make adjustments from the Scrn Bright screen:

1. Press the **ENTER**  button which will select the current setting.
2. Press either the **Up** or **Down**  /  arrow until the setting you desire is highlighted.
3. Press the **ENTER**  button to select the new setting and the brightness level of the display will be changed to the level you have selected.

9.10 Screen Sound Adjustment





The Scrn Sound screen is used to enable or disable a beep sound when a keypad button is depressed. When enabled, a beep will be emitted each time a keypad button is successfully pressed. This sound can be used to provide feedback as you use the command module keypad. To enable or disable the keypad sound from the Scrn Sound screen:

1. Press the **ENTER**  button which will select the current setting.
2. Press either the **Up** or **Down**  /  arrow until the setting you desire is highlighted.
3. Press the **ENTER**  button to select the new setting and the sound will set according to your selection.

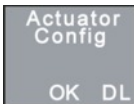
9.11 Actuator Config Menu Options



The Actuator Config menu allows the driver to make changes to the trailer actuator's settings using the DireLink NE's two-way digital network. To access the screens of the Actuator Config menu from the Config Options menu:

1. Press the **ENTER**  button and the Controller Config screen will appear.
2. Press the **Up** or **Down**  /  arrow and the Actuator Config screen will appear.

Press the **ENTER**  button until the first Actuator Config menu appears.

There are two (2) screens that comprise the Actuator Config menu; they are:



9.12 Actuator Reset



The Actuator Reset screen is where the driver can return all of the ActuLink Actuator settings to the original manufacturer's defaults. This is helpful if the driver would like to return the ActuLink settings to where they were when the ActuLink left the factory.

In order to activate the **Actuator Reset**:

1. Press the **ENTER** (↵) button when on the **Actuator Reset** screen.
2. An **ON** or **OFF** will appear underneath the current setting.
3. Press the **Up** or **Down** (▲/▼) arrow to toggle between **ON** and **OFF**.
4. Set the lower line to your desired selection and press the **ENTER** (↵) button.
5. The top line will change to your new selection.

Note: If you press the left or right arrows before pressing **ENTER** to accept your new selection, your new selection will NOT be saved before changing to a different menu screen.

When **ON** is selected in the **Actuator Reset** screen and the **ENTER** button is pressed, the ActuLink will return all settings to the original factory defaults.

9.13 Fluid Level Sensor



The Fluid Level Sensor ON/OFF screen allows the driver to enable or disable the ActuLink fluid level sensor (**if it is installed**) located in the ActuLink reservoir. The fluid level sensor is enabled (turned ON) when shipped from the factory. In normal operation, there should not be a reason to turn "OFF" the fluid level sensor. This screen is mainly intended to be used during ActuLink trouble shooting and service. The fluid level sensor protects the ActuLink's hydraulic pump from running "dry" (without brake fluid) and thereby damaging the pump. When the fluid level sensor indicates "OUT" of fluid, the ActuLink's motor will not run, thereby disabling the trailer brakes. This would be the same result if the motor did continue to run without fluid, however pump damage could be the result.

The Fluid Level Sensor screen is where the driver can turn ON or OFF the fluid level function.

In order to turn **ON/OFF** the Fluid Level Sensor function:

1. Press the **ENTER** (↵) button when on the Fluid Sensor screen.
2. An **ON** or **OFF** will appear underneath the current setting.
3. Press the **Up** or **Down** (▲/▼) arrow to toggle between **ON** and **OFF**.
4. Set the lower line to your desired selection and press the **ENTER** (↵) button.
5. The top line will change to your new selection.

Note: If you press the left or right arrows before pressing **ENTER** to accept your new selection, your new selection will NOT be saved before changing to a different menu screen.



10 Monitor Options Menu

10.1 Monitor Options Screens



The purpose of the **Monitor Options** menu is to allow the driver to view key vehicle and device parameters providing information on the operational status of the components and various network connections. The data that is displayed in the **Monitor Options** screen is able to be viewed only. None of the screens provide the ability to access or change the data.

To access the **Monitor Options** menu:

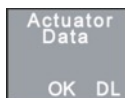

1. From the main menu, press and hold the **HOME**  button for 5 seconds.
2. After 5 seconds, the **Configure Options** screen will appear.
3. Press the Up Arrow  button and the **Monitor Options** screen will appear.

10.2 Controller Data Screens



← If DirecLink is turned ON in Section 9.3

To access the Controller Data Screens:

1. Press the **ENTER**  button on the Monitor Options screen and the Controller Data screen will appear.
2. Pressing either the **Up** or **Down**   arrows will switch between these screens.

There are five (5) screens that comprise the **Controller Data** menu, they are:

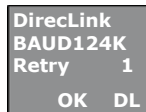

Pressing the Up or Down arrows will switch between these screens.

↑
If DirecLink is turned "ON" in section 9.3

10.3 Vehicle Mode

The **Vehicle Mode** screen displays the status of the DirecLink NE vehicle network connection. If the screen displays **Vehicle Mode** with a 4 character code (like PWM1), that indicates that the DirecLink NE has successfully established and connected to your vehicle's network. If the screen displays Vehicle Search and a number is counting from 0 to 5, that indicates that the DirecLink NE has not established a network connection with the vehicle and therefore is not operational.

10.4 MPH, KPH and RPM

The **MPH, KPH, RPM** screen displays those three parameters from the tow vehicle's network. The only time engine RPM is displayed is when velocity is zero. As soon as velocity is detected the engine RPM value disappears and only MPH and KPH are displayed. This screen is also used to indicate successful network communication between the DirecLink NE and the tow vehicle.

10.5 Controller Temperature, Amps and Volts

The **CTmp** screen displays the temperature of the Control Module circuit board in degrees F. The **CAmp** displays the amperage output of the controller to the "blue wire" during normal braking or running the manual override. The **CVlt** displays the voltage output to the "blue wire" during normal braking or running the manual override.

10 Monitor Options Menu

10.6 Vehicle Battery and Brake Light

This screen displays the vehicle battery voltage monitored from the black wire of the Delphi harness. The brake light voltage displays the voltage level of the red wire on the Delphi harness.

10.7 DirecLink BAUD

The DirecLink NE BAUD screen displays the BAUD rate that the "DL" network is currently using to communicate with the ActuLink Actuator mounted on the trailer. A higher value (124 is the highest) indicates good electrical connections. If the BAUD number is low, (for example 56) that is an indication that the "Blue Wire" electrical connection should be checked. This is most likely caused by a contaminated trailer to vehicle plug.

The "RETRY" number shows the number of times the DL network had to resend a message. A low number (like 1 to 10) is normal. If the number gets larger, this also indicates that the "Blue Wire" electrical connections should be checked.

NOTE: When the DirecLink NE is in "DL" mode, it constantly monitors the network connection integrity and if the connection degrades too far, the Controller will switch back to "C" mode (conventional PWM mode). Should this occur, the green "DL" will switch to a green "C". This is also an indication that the Blue Wire connection integrity should be checked.





10.8 Actuator Data Screens

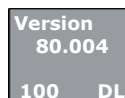
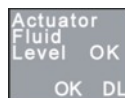

The Actuator Data screen allows the driver to connect and monitor parameters in "real time" on the ActuLink Actuator mounted on the trailer. There are five screens that comprise the Actuator Data menu, they are:



Actuator Data can be viewed through the Monitor Options screen. To access the **Monitor Options** menu:

1. From the main menu, press and hold the **HOME**  button for 5 seconds.
2. After 5 seconds, the **Configure Options** screen will appear.
3. Press the **Up Arrow**  button and the **Monitor Options** screen will appear.
4. Press the **ENTER**  button and the Controller Data screen will appear.
5. Press the **Up Arrow**  button and the Actuator Data screen will appear.
6. Press the **Enter**  button and the Motor Load screen will appear.

Pressing either the **Up** or **Down Arrow** / button will switch between these screens.

10.9 Motor Load



The Motor Load screen displays the current (amps) and voltage (volts) that are present inside the ActuatorLink actuator at the motor when the trailer brakes are applied. When viewing the Motor Load screen, while the truck and trailer are parked with the truck engine running, apply the manual override trigger on the DireLink NE Controller and watch the amps (on the top line) and the volts (on the second line). If the trailer and truck wiring connections are of good quality, the amperage value will be 15 or higher and the voltage reading will be 11 or higher when the manual override trigger is at 100%. If the values are less than those specified, this indicates that the truck and/or trailer wiring connections should be verified for proper wiring and good quality connections.

10.10 Vehicle Battery and Trailer Battery

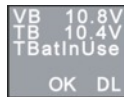
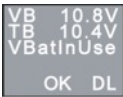

The Vehicle Battery and Trailer Battery screens allow the driver to monitor the voltages that are present at the ActuatorLink actuator on the trailer. When this screen is displayed, and the truck and trailer are parked, with the truck's engine running, the driver can run the manual override trigger and watch the voltage levels. When the third line of the screen reads "VBatInUse," the voltage being displayed on the first line Vehicle battery "VB" is being measured. To switch and test the trailer battery, push and hold the "ENTER" button for 3 seconds. The third line will change to "TBatInUse" thereby changing the input power source to the actuator from the vehicle battery to the trailer battery. The "TBatInUse" connection will remain for 3 seconds and then switch back to the "VBatInUse" if the manual override trigger is not active. When the manual override trigger is active, the "TBatInUse" will remain as long as the manual override trigger is active and the truck and trailer remain parked. In this mode, the driver can run the manual override trigger and the second line "TB" is being measured. Depending on the connection of the trailer battery, if it is directly connected to the charge line of the truck, the "TB" voltage reading will not just be measuring the trailer battery since the truck charge line will be boosting the voltage. If the trailer battery is connected to the truck's charge line with a limiting resistor (commonly used to prevent overcharging smaller breakaway batteries), then the "TB" voltage reading will more closely reflect only the trailer battery voltage. If the "VB" or "TB" voltage falls below 10 volts while running the manual override to 100%, the trailer and truck wiring should be checked for proper, good quality connections. Also the trailer battery condition should be checked.

10.11 Actuator Temperature



The Actuator Temperature screen allows the driver to view the internal temperature (degrees Fahrenheit) of the ActuatorLink actuator. The actuator temperature is a parameter that is constantly monitored by the DireLink NE system and if it reaches an excessive temperature that will affect braking performance (185°F), a red fault screen will automatically appear on the DireLink NE display to alert the driver.

10.12 Actuator Fluid Level

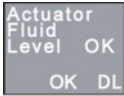

The Actuator Fluid Level screen displays the real-time fluid level in the actuator reservoir. The various level indicators are as follows:

OK = fluid level is adequate for proper actuator performance

LOW = additional brake fluid should be added to ensure proper actuator performance

OUT = SERIOUS PROBLEM - NO TRAILER BRAKES - Immediate service required

SHRT = the fluid level sensor wires are shorted - no fluid level status is available

DISC = the fluid level sensor wires are disconnected - no fluid level status is available

The Actuator Fluid Level is also constantly monitored by the DirecLink NE system and if the level drops to LOW or OUT, a red fault screen will automatically appear on the DirecLink NE's display to alert the driver.

10.13 Firmware Version

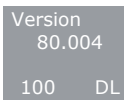

The Firmware Version screen displays the revision of the operating system installed and is used for reference in trouble shooting and service.

11 Fault Codes and Trouble Shooting

11.1 When Faults Are Detected

The DirecLink NE automatically monitors many critical operational parameters. When a fault is detected, a RED screen will appear with a description of the fault and the module containing the fault. A "C" for Controller, a "K" for a Keypad fault and an "A" for the ActuLink actuator will be displayed in the bottom center of the screen. The RED screen will only appear if the Command Module is on one of the MAIN menu screens (Brake Scale, Low Speed Brake, Trans Temp). The RED screen will be displayed for 3 seconds, disappear for 5 seconds and reappear for 3 seconds as long as the fault exists. The fault will be displayed continuously until the fault is cleared. If more than one fault is detected at the same time, the fault screens will cycle through the existing faults until they are corrected. If the Command Module is on a Config., Monitor or Fault menu screen when a fault is detected, the RED screen will NOT appear. However, the module containing the faults will be displayed in the center of the bottom line in red (C , K or A).

To clear a fault screen, the root cause of the fault must be corrected. To learn more about a fault, use the fault viewer menu as outlined in sections 11.3 and 11.4. The fault screens will provide information regarding the problems that need to be corrected. Section 11.5 provides a brief description of the main faults and methods of correcting them. The table below shows a summary of faults.

11.2 Fault Descriptions

Code Description	Additional Information
System OK	OK appears in bottom center of the screen
P3, P4, P5 Low Voltage	RJ connector low voltage
Blue Wire Short	Brake current/signal wire short
OBDII Low Voltage	OBDII or DB9 disconnected
No OBDII Communication	
P3, P4, P5 Short	RJ connector short
P3, P4, P5 Overcurrent	RJ connector Overcurrent
Controller High Temp	Control Module overheating
White Wire Ground Open	Ground wire on Delphi disconnected
Black Low Voltage	Black wire on Delphi disconnected
Unit Overcurrent	ActuLink overcurrent
Actuator High Temp	ActuLink overheating
Unit Low Voltage	ActuLink low voltage
Unit Breakaway	Trailer Breakaway Switch Active (with Blue Wire still connected)
Fluid Level Low	ActuLink Brake Fluid Level Low
Fluid Level Out	ActuLink Brake Fluid Level Out
Fluid Level Disc	ActuLink Fluid Level Sensor Disconnected
Fluid Level Short	ActuLink Fluid Level Sensor - Electrical Short



11 Fault Codes and Trouble Shooting

11.3 Fault Viewer Screens



The **Fault Viewer** menu allows the driver to view the details of the general faults that appear on one of the main menu screens as outlined in section 11.1 of this manual. When a fault appears on the screen, it may be necessary to get more information about the fault. This information is available in the **Fault Viewer** screen.

To access the **Fault Viewer** menu:

1. From the main menu, press and hold the **HOME**  button for 5 seconds.
2. After 5 seconds, the **Configure Options** screen will appear.
3. Press the **DOWN ARROW**  button and the Fault Viewer screen will appear.
4. Press the **ENTER**  button and the **Controller Fault** screen will appear.

There are three (3) screens that are accessible under the **Fault Viewer** menu:



Pressing the Up or Down arrows will switch between these screens.

11.4 Select the Controller Fault Screen

Press the **ENTER**  button on the **Controller Fault** screen and if one or more faults exists with the Controller, the first fault in the list will appear:

If no faults are present, screen will read "NONE". If only one fault is active, it will be the only one on the screen. If more than one fault is active, the screen will cycle through the faults showing each one for 3 seconds. When the faults are corrected, they will not appear in the fault cycle.

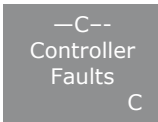

The DireLink NE continually monitors for the presence of faults so that when a fault is corrected, the DireLink NE removes it from the list. This means that the driver can have the specific fault displayed on the fault screen while making corrections and when the fault is corrected, it will disappear thereby giving confirmation to the driver that the fault is fixed.

The fault viewing process works the same for the "C", "K" and "A" type faults.

11 Fault Codes and Trouble Shooting

11.5 Descriptions of Major Faults and Resolutions

Fault Screen	Probable Cause of Faults and Trouble Shooting Methods
Controller BLK vLow C NC	This screen indicates that the black wire (12V +) of the four wire Delphi connector (connector #4 as outlined on page 1 of this manual) is either not connected properly, has an intermittent connection or there is no power from the vehicle electrical system. This fault completely disables your trailer brake system.
Controller Gnd Open C NC	This screen indicates that the white wire [ground (-)] of the four wire Delphi connector (connector #4 as outlined on page 1 of this manual) is either not connected properly or has an intermittent connection. This wire is to be connected to the negative terminal of the tow vehicle battery only. This fault completely disables your trailer brake system.
Controller BluShort C NC	This screen indicates that the blue wire trailer brake voltage or signal wire of the four wire Delphi connector (connector #4 as outlined on page 1 of this manual) is shorted to ground. This fault completely disables your trailer brake system.
Controller OBD vLow C NC	This screen indicates that the connection between the DirecLink NE and the OBDII connector is loose or disconnected. These are connections 3 with 4 or connections 4 with 7 as outlined on page 3 of this manual. Tightening or reconnecting the cables should resolve this problem. This fault results in the DirecLink NE operating in emergency mode as indicated by a "red" braking bar while vehicle braking.
Brake Scale +03 OK NC	If the trailer connector is properly plugged into the tow vehicle's trailer wiring receptacle and the screen still displays a red NC, check the following; 1) The display to determine if any faults are indicated. 2) Verify that the wiring of the trailer connector and the tow vehicle receptacle absolutely correspond by wire function (NOT BY WIRE COLOR). 3) Ensure that the connector plug and receptacle are clean and free of corrosion. 4) Use the Monitor Menu to verify all electrical connections (including the Brake Light voltage) and verify the brake controller output in voltage and amps. 5) If the trailer braking system is electric drum brakes, ensure the trailer brake magnet ground is properly connected per the manufacturer's instructions.
	The DirecLink NE screen is dark/not functioning. There are three potential causes: 1) The vehicle is turned off and the DirecLink NE is asleep. Press the brake pedal to wake it up. 2) The spiral cable (cable #5 as outlined on page 1 of this manual) is not properly connected to either the control module or the command module which results in a lack of electrical power to the command module. If the spiral cable is properly connected, unplug it from the control module and re-plug it into one of the other two connectors on the front of the control module. If this does not resolve the problem, the cable might need to be replaced. To isolate the problem to the command module, check the LEDs on the front of the control module. If the PWR LED is solid green and the S-1 LED is flashing green, then the control module has power and is functioning properly. 3) If the LEDs on the front of the control module are not functioning as outlined above, this verifies that there is no power on either the OBDII connector or the Delphi connector. You must restore power to resolve this problem. If the "red" LED is flashing on the control module, there most likely is a wiring problem with the spiral cable or possibly with the wiring to the control module.

11 Fault Codes and Trouble Shooting

11.5 Descriptions of Major Faults and Resolutions, continued...

Fault Screen	Probable Cause of Faults and Trouble Shooting Methods
Actuator Fluid Out A DL	This screen indicates that the actuator is out of brake fluid and therefore, the trailer brakes are inoperable. TAKE IMMEDIATE ACTION TO REPAIR THIS CONDITION.
Actuator Fluid Low A DL	This screen indicates that the actuator is low on Brake Fluid, however, there remains enough brake fluid in the reservoir for the actuator to continue to operate. The driver should add fluid to the actuator as soon as possible.

Limited Lifetime Warranty

DirecLink Warranty

Tuson RV Brakes, LLC (hereafter referred to as Tuson) warrants the DirecLink trailer brake controller to be free of defects in material and workmanship, under normal use, for a period of five (5) years from the original consumer purchase date. At Tuson's sole option, Tuson will repair or replace the defective product with a like product. Replacement product or parts may include remanufactured or refurbished parts or components. This warranty applies only to the first consumer purchaser, is nontransferable, and is limited to components supplied with the DirecLink trailer brake controller product. The purchase or use of the DirecLink trailer brake controller constitutes acceptance of the conditions stated in this document. Tuson makes no guarantee, warranty, or representation regarding the suitability or legality of this product. It is the consumer's responsibility to ensure regulatory compliance before purchasing or using this product. The consumer agrees to operate this product in keeping with all laws governing its use. Under no conditions will Tuson be responsible for anything other than the repair or replacement of the original product.

Limitation of Liability and Warranty Exclusions

Tuson's liability is limited to the cost of repair or replacement of the DirecLink trailer brake controller. This limited warranty excludes, but is not limited to damage, deterioration, or malfunction due to negligence, abuse, accident, improper use, misuse, improper installation, failure to follow supplied instructions, alteration, modification, unauthorized repair or attempted repair, external causes, normal wear and tear, or any other cause which does not relate to a product defect. This limited warranty also excludes any incidental, consequential, or other claims, damages, or losses, even if advised of the possibility of such, including against the consumer by any other party. There are no other warranties, express or implied, including implied warranty of merchantability and fitness for a particular purpose. All disputes will be handled in accordance with Illinois state laws.

For assistance with your DirecLink trailer brake controller, please call 800-968-8766.

For more information about DirecLink, visit our website at www.direclink.com