

# DirecLink

Trailer Brake Controller

Base Model

Installation and  
Users Guide



Tuson RV Brakes, LLC  
475 Bunker Court  
Vernon Hills, IL 60061

[www.direclink.com](http://www.direclink.com)

May 2011

---

# Contents

1	DirecLink Components.....	01
1.1	Inside the box.....	01
2	Quick Start.....	02
2.1	About Quick Start.....	02
2.2	Quick Start Steps.....	02
3	Initial Connection and Test.....	03
3.1	About the Test.....	03
3.2	Electrical Connections.....	03
3.3	Connection Sequence.....	03
3.4	First Time Power-Up.....	04
4	Final Installation of Modules and Cables.....	05
4.1	Final Installation Sequence .....	05
4.2	Final Installation Sequence (continued).....	06
5	Setting Brake Scale - Initial Operation.....	07
5.1	Brake Scale (Home Page).....	07
5.2	Heavy Trailers.....	07
5.3	Confirm Trailer Connection.....	07
5.4	Road Test and Fine Tuning Brake Scale.....	08
5.5	DirecLink Sleep Mode.....	08
6	Manual Braking.....	09
6.1	Manual Braking.....	09
7	7.0 Screen and Button Functions.....	10
7.0	Screen and Button Functions.....	11
8	Main Menu Navigation and Settings.....	12
8.1	Main Menu Screens.....	12
8.2	Brake Scale (Home Screen).....	12
8.3	Low Speed Brake.....	12
8.4	Trans Temp.....	13
9	Configure Option Menu.....	14
9.1	Configure Options.....	14
9.2	Controller Config and Keypad Config Screens.....	14
9.3	Controller Config Menu Options.....	14
9.4	Trailer Size.....	15
9.5	Brake Level When Stopped.....	15
9.6	Max Brake Limit.....	16
9.5	Controller Reset.....	17
9.8	Keypad Config Menu Options.....	17
9.9	Screen Brightness Adjustment.....	18
9.10	Screen Sound Adjustment.....	18
10	Monitor Options Menu.....	19
10.1	Monitor Options and Controller Data Screens.....	19
10.2	Vehicle Mode.....	19
10.3	Vehicle Battery and Brake Light Voltage.....	19
10.4	Controller Temp, Amps and Volts.....	19
10.5	MPH, KPH, Engine RPM.....	20
11	Faults Codes and Trouble Shooting.....	21
11.1	When Faults Are Detected.....	21
11.2	Fault Codes and Descriptions.....	21
11.3	Fault Viewer Screens.....	22
11.4	Select the Controller Fault Screen.....	22
11.5	Descriptions of Major Faults and Resolutions.....	23
12	DirecLink Menu Navigation Overview.....	24
12.1	Menu Structure Overview - Menu Levels.....	24
	Limited Lifetime Warranty.....	25

# 1 DirecLink Components



## 1.1 Inside the box

Control Module	#1
Command Module	#2
OBDII Cable	#3
Delphi Harness	#4
Spiral Cable	#5
Flush Dash Mount	#6
Swivel Dash Mount	#7
Alcohol wipe	not shown
5 Cable Ties	not shown
Users Manual	not shown

# Read and Save This Manual

- Before beginning installation, read and become familiar with these instructions.
- Save this manual and store it in your tow vehicle for future reference.
- Improper installation and operation could cause serious or fatal injuries and/or property damage.

## Please Note:

The DirecLink trailer brake controller works with 2 - 8 electric drum brakes and electric-hydraulic trailer brake actuators. It automatically detects which type you have and configures itself accordingly.

---

## 2 Quick Start

---

### 2.1 Quick Start

By following the steps outlined in sections 3-7 of this manual, you can install and use the basic features of the DirecLink trailer brake controller. However, we strongly encourage you to read and utilize the more advanced features of DirecLink which are outlined in sections 8 - 12 of this Installation and Users Guide.

### 2.2 Quick Start Steps

1. Initial Connections and Test
2. Final Installation of Modules and Cables
3. Setting Brake Scale
4. Manual Braking

## 3 Initial Connection and Test

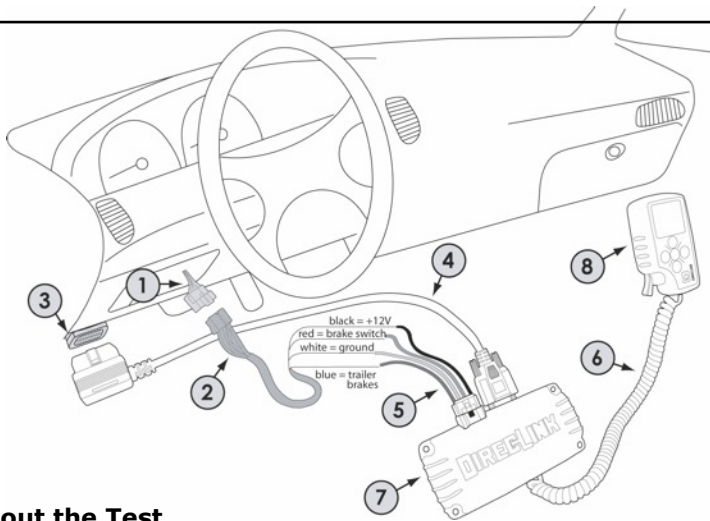

### 3.1 About the Test

The purpose for the initial test, prior to securing the cables and mounting the modules is to verify that the required wiring connections are available and functioning properly. By checking this functionality first, it is easier to make any repairs or corrections while all wiring and components are easily accessible.

### 3.2 Electrical Connections

The required electrical connections are indicated by the numbers in the diagram above:

1. Vehicle specific trailer wiring connector (already in vehicle or can be purchased)
2. Vehicle specific trailer wiring harness (must buy separately)
3. Vehicle OBDII connector (already in vehicle)
4. OBDII to DB9 Cable (included with DireLink)
5. Delphi 4 Wire Harness (included with DireLink)
6. Spiral Cable (included with DireLink)
7. DireLink Control Module
8. DireLink Command Module

### 3.3 Connection Sequence

With the vehicle ignition turned OFF and the trailer DISCONNECTED from the vehicle, make the wiring connections in the following order:

**First:** connect 2 with 5. If your vehicle is not equipped with a harness that plugs directly into the DireLink's Delphi connector, than you must use the Delphi 4 wire harness included in your package. The diagram above shows the functions of the four wires of the Delphi harness. These wires must be connected to the vehicle by function and NOT by color. The label attached to the Delphi harness contains common wire function and color for various vehicle manufacturers. If your vehicle is not listed on this label, consult your owner's manual to determine your vehicle's wiring function by color. Once you have determined the correct wire connections for the four wire harness, use a crimp-type connector to securely fasten the wires together.

Once you have finished securely connecting 2 with 5 as outlined above, complete the connection sequence as follows:

Second: connect 1 with 2  
Third: connect 3 with 4  
Fourth: connect 4 with 7

Fifth: connect 5 with 7  
Sixth: connect 6 with 7\*  
Seventh: connect 6 with 8

\* Use any of the 3 RJ connectors in Item 7; select the connector that makes routing of the spiral cable to item 8 as easy as possible.

---

# 3 Initial Connection and Test

---

## 3.4 First Time Power-Up

3.4.1 After the electrical wires and cables have been installed per the previous section, the next step is to wake-up the DirecLink and verify correct operation. While viewing the Command Module display screen, start the vehicle and depress and release the brake pedal. It is not necessary to press any buttons since the following configuration process is fully automated. If all electrical connections are correct the display will turn on with a blue background and white text reading "DirecLink" as shown in (#1) below:

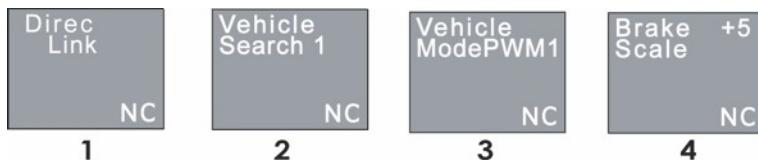

3.4.2 The "VEHICLE SEARCH \_\_\_" screen (#2) is displayed next. During this time the DirecLink is searching for the type of vehicle network that is connected. Once the network is found, screen (#3) "VEHICLE MODE \_\_\_" is displayed. In the (#3) example, PWM1 is shown. If PWM, VPW, CAN or ISO appear in this screen, that indicates a successful connection has been made with your vehicle. Once DirecLink connects, it automatically switches to the Brake Scale screen, #4 above.

Note: The "VEHICLE SEARCH \_\_\_" screen will continue to cycle through the various numbers and not proceed to the next screen if the following conditions exist:

1. The vehicle ignition is not turned to the "ON" position
2. The vehicle network is not supported by DirecLink (see list below)

### SUPPORTED VEHICLE NETWORKS

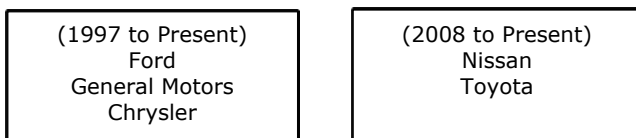

\* Not all models with all years have been tested and verified to operate with the DirecLink, however significant sample testing has been performed spanning the range of vehicles in the supported vehicles networks (listed above) and indicate a wide compatibility with the manufacturers and years listed.

3.4.3 After the vehicle network connection is successfully completed, screen (#4) "BRAKE SCALE \_\_\_" is displayed. The appearance of this screen indicates that the DirecLink has successfully established communication with your vehicle and is now operational.

3.4.4 The red "NC" that appears in the lower right corner of the display indicates that the DirecLink is not connected to a trailer braking system. Once the trailer is connected to the vehicle and a braking system is detected, the red "NC" will turn to a green "C".

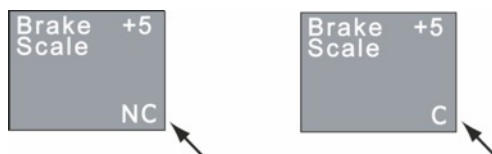

---

## 4 Final Installation of Modules and Cables

---

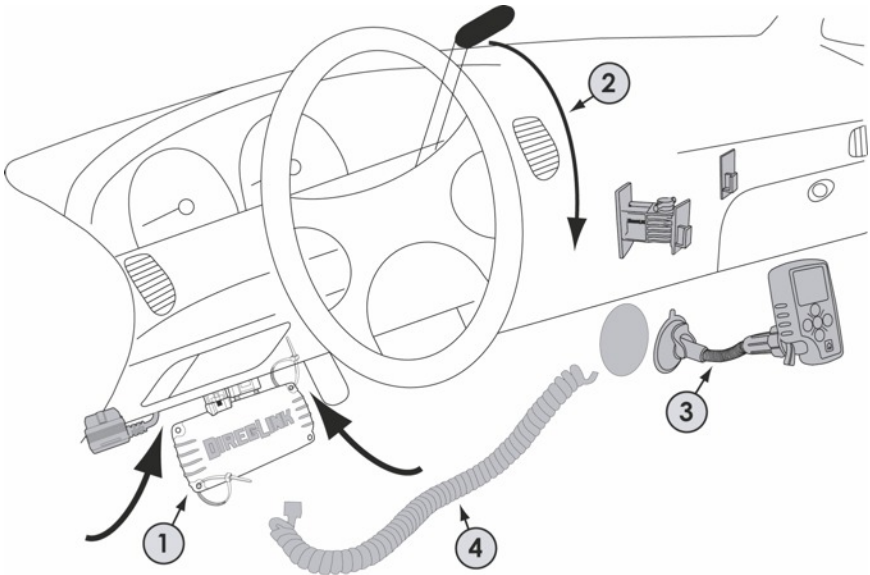

### 4.1 Final Installation Sequence

After successfully completing the initial connections and power-up described in section 3, perform the final installation in the following sequence:

1. Using the cable ties provided, secure the OBDII cable, Delphi harness and the control module up underneath the dash with the RJ connectors (phone style connectors) facing out toward the driver to make it easy to plug in the spiral cable. Route the cable ties through at least two of the four corner holes in the control module case and attach them to solid objects under the dash such as support brackets. Be sure all cables are securely fastened to prevent interference with the drivers feet. The control module can be mounted in any orientation without affecting operation.
2. Select the location to mount the command module. There are two different styles of dash mounts that are included with the DirecLink; flush mount and swivel mount. Both use a peel-off adhesive back for mounting. It is very important to clean the selected mounting surface with an alcohol wipe (included) and let the surface dry before attaching the mount. In selecting a good mounting location be especially aware of the gear shift lever. Make sure that the selected location does not interfere with the entire travel of the gear shift lever when shifting from park all the way down to low gear.
3. After the command module is mounted in an easily viewable and reachable location, attach the spiral cord to any of the three RJ connectors on the control module and connect it to the bottom of the command module.

---

## 4 Final Installation of Modules and Cables

---

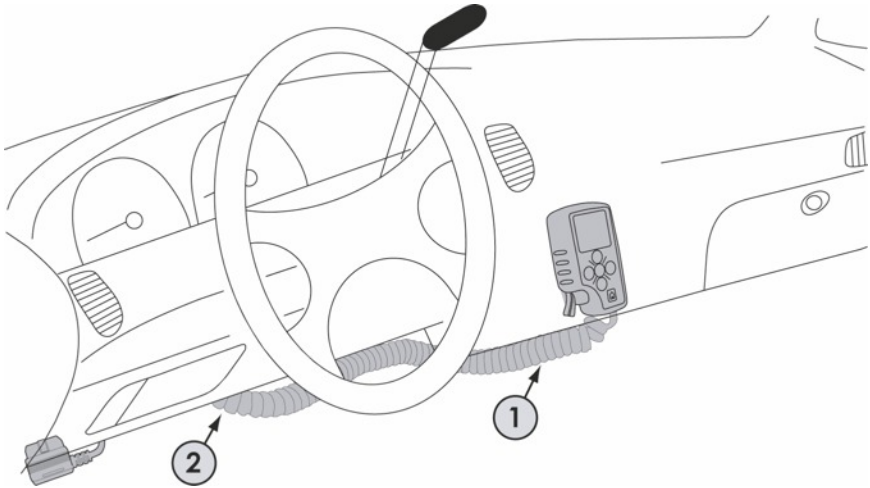

### 4.2 Final Installation Sequence

When the DirecLink is properly mounted, the only parts visible are the command module, spiral cable and possibly the OBDII connector (depending on the location of the connector in the vehicle).

1. The spiral cord should be routed to the control module in a manner that keeps the cord somewhat tight and against the dash to avoid interfering with the vehicles moving parts or the driver's legs.
2. If needed, a cable tie can be used under the dash by the control module to take any excess slack out of the spiral cable. Do not make the spiral cable too tight and keep enough slack to be able to remove the command module from the mount and hold in your hand to operate the buttons.



**Warning!**

All wiring must be connected as instructed in this manual for the DirecLink to operate correctly. Failure to connect all the wires correctly may cause a loss of trailer brakes resulting in serious or fatal injury and/or property damage.



**Warning!**

The white wire of the Delphi connector (connector #5 in the diagram on page 3) must be connected to the negative terminal of the tow vehicle battery. Improper ground will result in the loss of trailer brakes which may result in serious or fatal injuries and/or property damage.



**Warning!**

DO NOT connect the black wire of the Delphi connector (connector #5 in the diagram on page 3) to any vehicle power supply line or fuse panel that could cause circuit overload or damage to tow vehicle wiring and vehicle electronics.



---

# 5 Setting Brake Scale - Initial Operation

---



## 5.1 Brake Scale (Home Screen)

The HOME screen for the DirecLink is the **Brake Scale** screen. This is the first screen in the main menu and it appears upon completion of a successful power-up or when the **HOME**  button is pressed.



The **Brake Scale** number represents the level of trailer braking that the DirecLink will apply to the trailer brakes when the tow-vehicle brakes are applied. The value can be adjusted from +1 to +20 with +1 being very light braking and +20 being very heavy braking. (The default level is set at +3.)

### To adjust the Brake Scale:

1. Press the up or down  /  arrows on the keypad and this will immediately raise or lower the Brake Scale level. THERE IS NO NEED TO PRESS ENTER. The level of Brake Scale can be changed at any time.

## 5.2 Heavy Trailers

If your trailer weighs more than 10,000 lbs., you should configure the DirecLink to LARGE trailer as explained in section 9 of this guide. This increases the Brake Scale levels from +1 to +40 providing you with 40 levels of Brake Scale giving you greater flexibility in finding the optimal braking level for your larger trailer. **SEE SECTION 9.**

## 5.3 Confirm Trailer Connection

Now that the DirecLink has successfully powered-up and after properly hitching the trailer to the tow vehicle, you can verify the trailer's electrical connection. If the DirecLink has properly detected the trailer brake system, a green "C" will appear in the lower right hand corner of the display screen. If a red "NC" appears in the lower right hand corner of the display screen after the trailer's electrical plug has been attached to the tow vehicle's receptacle, see page 23 of this manual in the Faults and Trouble Shooting section, and do NOT tow the trailer.

---

# 5 Setting Brake Scale - Initial Operation

---

## 5.4 Road Test and Fine Tuning Brake Scale

Once you have a green "C" in your display screen and the trailer is properly hitched to the tow vehicle, you are ready to make some slow speed stops to verify the correct level of Brake Scale.

Position the tow vehicle and trailer in a low traffic area on a hard, flat, dry surface and follow these steps:

1. Accelerate to approximately 25 miles per hour and make a normal stop. The trailer brakes should provide firm braking without the trailer tires locking. Inversely, the trailer should not push against the tow vehicle during braking.
2. If the trailer tires lock, reduce the Brake Scale until this is resolved. If the trailer pushes the tow vehicle raise the Brake Scale until this problem is resolved.
3. Once you are confident of the Brake Scale level, make several stops at 50 miles per hour and confirm the level of Brake Scale or readjust as needed.

## 5.5 DirecLink Sleep Mode

Once the vehicle's engine is turned off, the DirecLink will go into "sleep mode" after 5 minutes causing the Command Module screen to turn off. Once the DirecLink enters "sleep mode" the brake pedal must be depressed to resume operation. The 5 minute "sleep mode" can be delayed if any button or the trigger on the Command Module is activated, or if the brake pedal is pushed while the engine is turned off.

## 6 Manual Braking

### 6.1 Manual Braking

The DirecLink is equipped with a "trigger" that provides the driver the ability to manually apply the trailer brakes from 0 to 100% braking force. As the trigger is pulled a bar appears from left to right on the display with a numerical percentage corresponding to the amount of manual braking being applied. When the trigger is released, the trailer brakes are released and the bar disappears from the display.

Trailer braking during manual operation using the trigger does NOT use the Brake Scale settings. The percentage braking force displayed is the percentage of braking force of the trailer brake system. Keep this in mind as you use the manual over-ride trigger as it is possible that you will lock your tires if you apply very high levels of manual braking.



**Warning!**

Manual brake operation using the trigger manual over-ride may not disengage the Cruise Control on some vehicles.



**Warning!**

Trailer brake lock-up may cause a loss of control of the trailer and/or the tow vehicle. This may cause serious or fatal injuries and/or property damage. Take care in applying trailer brakes in manual operation and always set your Brake Scale so the trailer tires do NOT lock up during braking.

### **This concludes the Quick Start.**

You are ready to use the basic functions of the DirecLink.

The DirecLink can be very precisely adjusted, it has more functionality and diagnostic capability. To learn more about these features, read the remainder of this manual. You will get more from your DirecLink trailer brake controller and have a much better understanding of how it works.

## 7 Screen and Button Functions

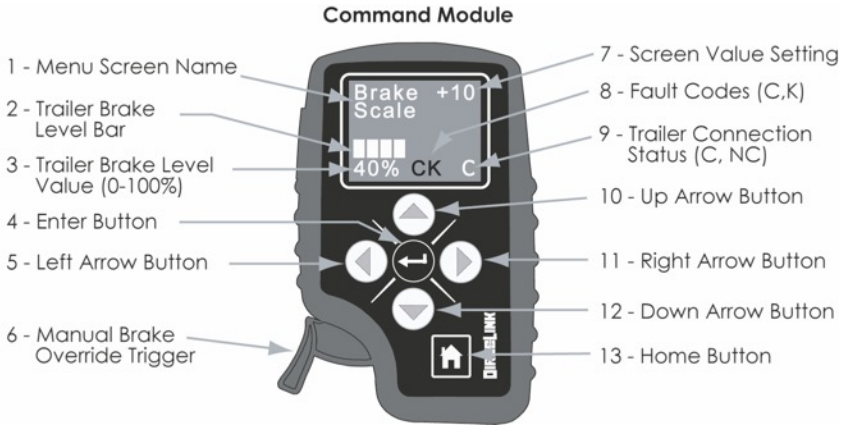

Feature	Description
1- Menu Screen Name	This area of the screen displays the title of the screen you are viewing.
2- Trailer Brake Level Bar	This moving bar indicates the level of trailer braking signal being sent from the DireLink to the trailer from 0 to 100%. When using the manual trigger, the bar is white in color; under normal braking using the vehicle brake pedal, the bar is yellow in color; and if network communication is lost the bar is red in color.
3- Trailer Brake Level Value	This numeric value corresponds with the Trailer Brake Level Bar and also indicates the level of trailer braking signal being sent from the controller to the trailer (from 0 to 100%).
4- Enter Button	This button is used to accept a value or selection on the menu screen. Pressing the enter button communicates this selected value to the DireLink.
5- Left Arrow Button	The left arrow button is used to navigate in reverse direction through the Main Menu screens. It is also used to navigate to the upper menu levels when in the configure and diagnostics screens.
6- Manual Brake Override Trigger	The manual brake override trigger allows the operator to manually apply from 0 to 100% of the trailer brakes by sliding the spring-loaded trigger into the housing. Releasing the trigger also releases the trailer brakes.
7- Screen Value Setting	The screen value setting indicates the accepted and/or current value that is set for the menu screen being displayed. In the example above, the Brake Scale is set to +10. Other menu screens have text values like OFF/ON and others have percentage values that can be changed.

## 7 Screen and Button Functions

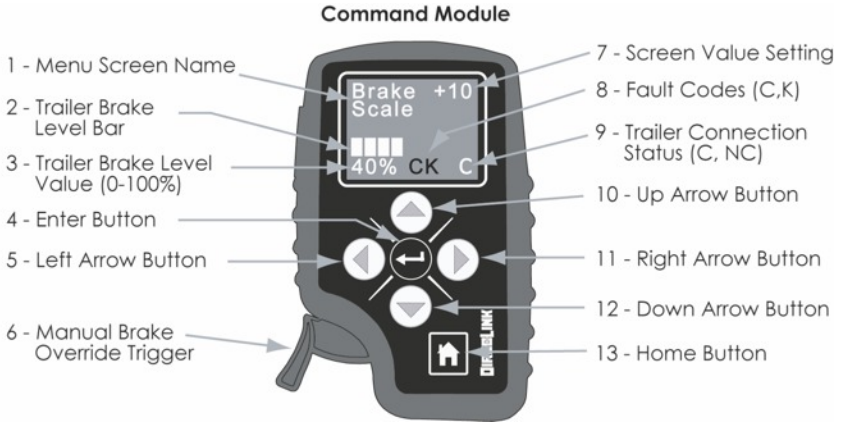

Feature	Description
8 - Fault Codes	<p>The fault code section of the display is used to alert the driver of device operational problems many of which can cause the trailer braking system to not function at all or at a reduced performance level. The two letter designators indicate the device in the braking system that is experiencing a fault:</p> <p style="text-align: center;">C = the <b>Controller</b> (DireLink) K = the <b>Keypad</b> (DireLink)</p>
9 - Trailer Connection Status	<p>The trailer connection status indicates the DireLink's communication status with the trailer braking components located on the trailer. The two designations are:</p> <p style="text-align: center;">NC = <b>Not Connected</b> C = <b>Connected</b> (using conventional PWM braking signal)</p>
10 - Up Arrow Button	<p>The up arrow button is used to increase a data value for adjustment and is also used to scroll up in certain menus. In the configure and diagnostics screens, the up arrow is used to scroll through the selections at the current menu level.</p>
11 - Right Arrow Button	<p>The right arrow button is used to navigate in the forward direction through the Main Menu screens. It is also used to navigate to the upper menu levels when in the configure and diagnostics screens.</p>
12 - Down Arrow Button	<p>The down arrow button is used to decrease a data value for adjustment and is also used to scroll down in certain menus. In the configure and diagnostic screens, the down arrow is used to scroll through the selections at the current menu level.</p>
13 - Home Button	<p>The home button is used for returning to the Brake Scale main menu screen.</p>

---

## 8 Main Menu Navigation and Settings

---

### 8.1 Main Menu Screens

There are three (3) screens that comprise the main menu of the DireLink, they are:



### 8.2 Brake Scale (Home Screen)

This screen is covered in section 5 of this manual.

### 8.3 Low Speed Brake

The **Low Speed Brake** screen is accessed by pressing the RIGHT ARROW (▶) button when on the **Brake Scale** screen.



The **Low Speed Brake** value allows the driver to adjust the amount of braking that the DireLink applies at low vehicle velocities such as in town driving. The selectable values go from -5 to +5. The **-5** value is the **most reduction** that can be made to the low velocity brake level and the **+5** is the **most additional** braking that can be adjusted to the low velocity brake level for a given **Brake Scale** setting. A Low Speed Brake setting of **0** will **not change** the low velocity brake levels of the **Brake Scale** setting.

In order to adjust the **Low Speed Brake** settings:

1. Press the **ENTER** (↵) button when on the **Low Speed Brake** screen and a number will appear on the line underneath the current setting.
2. Press the Up or Down (▲/▼) arrow button to change the bottom number to the desired setting (from -5 to +5).
3. Set the lower number to your desired value and press the **ENTER** (↵) button.
4. The top line will change to your new selected number.

**Note:** If you press the left arrow, right arrow or home buttons before pressing the **ENTER** button, the new **Low Speed Brake** setting will NOT be saved before moving to the next screen.

The need for a **Low Speed Brake** adjustment results from the different configurations, sizes and conditions of trailer braking systems. To determine the best **Brake Scale** and Low Speed Brake settings for your tow vehicle-trailer combination, leave the **Low Speed Brake** setting at 0 and adjust **Brake Scale** setting to the desired amount of trailer braking at 50 mph. As you reach the desired **Brake Scale** setting, when your vehicle velocity is under 30 mph, if the braking is too aggressive, adjust the **Low Speed Brake** setting to -1, -2 etc. Each negative increment will decrease the aggressiveness of braking under 30 mph. If the braking is not aggressive enough under 30 mph, adjust the **Low Speed Brake** setting to +1, +2 etc. This will increase the aggressiveness of the brake levels under 30 mph. As you decrease or increase the **Low Speed Brake** settings, it may be necessary to decrease or increase the **Brake Scale** settings in order to find the ideal match of the two settings for your tow vehicle-trailer combination.

---

## 8 Main Menu Navigation and Settings

---

### 8.4 Trans Temp

The **Trans Temp** screen is accessed by pressing the **RIGHT ARROW**  button from the **Low Speed Brake** screen. The transmission fluid temperature is displayed in degrees Fahrenheit (F). This screen enables the driver to monitor the transmission for possible over-heating while pulling heavy loads in hot weather or up steep grades. Consult your vehicle's owners manual for the normal operating temperature of your transmission.



The **Trans Temp** screen will only appear on certain Ford and General Motor vehicles where DirecLink can access the transmission data on the tow vehicle network. On vehicles where DirecLink cannot access the transmission data, the **Trans Temp** screen will not appear or will display N/A if not available. In these cases the only operational main menu screens will be the **Brake Scale** and **Low Speed Brake** screens.

---

# 9 Configure Option Menu

---

## 9.1 Configure Options

The purpose of the **Configure Options** menu is to allow the driver to enable some additional features of the DireLink or readjust existing settings. The additional features contained in the **Configure Options** menu are turned OFF by default. Once turned ON by the driver, they remain ON until turned OFF.

To access the **Configure Options** menu, from the main menu:

1. Press and hold the **HOME**  button for 5 seconds.
2. After 5 seconds, the **Configure Options** screen will appear.



## 9.2 Controller Config and Keypad Config Screens

Under the Configure Options screen there are two (2) sub menus: Controller Config and Keypad Config. These sub menus allow you to adjust various settings of the DireLink as outlined in the sections below.

To access the Controller Config and the Keypad Config sub menus, from the Configure Options screen:

1. Press the **ENTER**  button and the Controller Config screen will appear.



Pressing the up or down arrows will switch between these screens.

## 9.3 Controller Config Menu Options

The purpose of the Controller Config menu is to enable additional DireLink features that could assist in achieving the best brake controller performance for their specific tow vehicle-trailer configuration. To access the screens of the Controller Config menu:

1. Select the Controller Config Menu screen as outlined above.
2. Press the **ENTER**  button and the first of the Controller Menu Screens will appear: Tralr Size.

There are four (4) screens that comprise the **Controller Config** menu, they are:

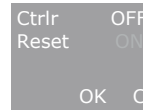
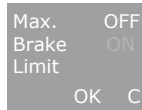
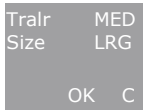

Pressing the up or down arrows will switch between these screens.



---

## 9 Configure Option Menu

---

### 9.4 Trailer Size



The **Trailer Size** screen allows the driver to select between **MED** (medium) and **LRG** (large) trailer sizes. The default setting is **MED**. The **MED** setting is a scaling factor that is applied to the **Brake Scale** setting. The **MED** setting is designed for trailers weighing up to 10,000 lbs. The **LRG** setting is designed for trailers that exceed 10,000 lbs. By having these two trailer size settings and having 20 levels of **Brake Scale** for each setting, that gives the driver 40 levels of **Brake Scale** to choose from in order to find the ideal trailer brake setting. Depending on the condition or configuration of your trailer's brake system, and regardless of its actual weight, you may select either the **MED** or **LRG** trailer setting to achieve optimal trailer braking performance. The **DireLink** will operate properly in either **Trailer Size** setting regardless of the trailer size so do not hesitate to select the setting that provides your preferred level of trailer braking.

**In order to switch between MED and LRG trailer settings:**

1. Press the **ENTER** (↔) button when on the **Trailer Size** screen.
2. Either **MED** or **LRG** will appear underneath the current setting.
3. Use the **Up** or **Down** (▲/▼) arrow to toggle between **MED** and **LRG** on the lower line.
4. Set the lower line to your desired selection and press the **ENTER** (↔) button.
5. The top line will change to your new selection.

**NOTE:** If you press the left or right arrows before pressing **ENTER** to accept your new selection, your new selection will **NOT** be saved before changing to a different menu screen.

### 9.5 Brake Level When Stopped



The **Brake Level w/Stopped** screen allows the driver to set a desired percentage level of trailer brakes to be applied when the tow vehicle-trailer is at a stop. The level can be set from 5% to 30%. When activated, the **DireLink** adjusts the trailer brakes up to the setting when tow vehicle-trailer velocity is zero. This feature is helpful when stopping on steep grades or on slippery boat ramps. By having the trailer brakes applied when stopped it helps keep the tow vehicle and trailer stationary.

**In order to set the Brake Level w/Stopped value:**

1. Press the **ENTER** (↔) button when on the **Brake Level w/Stopped** screen.
2. A number will appear underneath the current setting.
3. Press the **Up** or **Down** (▲/▼) arrow to increment the value of the lower line up or down.
4. Set the lower line to your desired value and press the **ENTER** (↔) button.
5. The top line will change to your new selection.

**NOTE:** If you press the left or right arrows before pressing **ENTER** to accept your new selection, your new selection will **NOT** be saved before changing to a different menu screen.

After setting the **Brake Level w/Stopped** value to something other than zero (0), you will notice that the **Brake Bar** on the screen will indicate the value you set when the tow vehicle-trailer comes to a stop.

---

## 9 Configure Option Menu

---





### 9.6 Max. Brake Limit



**ADDED TO THE  
MAIN MENU  
SEQUENCE**

The Max. Brake Limit screen is where the driver can turn ON or OFF the Max. Brake Limit function. The Max. Brake Limit function operates as a maximum brake level limit on the DirecLink output to the trailer brakes. If the Max. Brake Limit feature is turned ON, then an additional screen is added to the Main Menu sequence for the Max. Brake Limit.

In order to turn ON the Max. Brake Limit function:

1. Press the **ENTER**  button when on the Max. Brake Limit screen.
2. An ON or OFF will appear underneath the current setting.
3. Press the **Up** or **Down**  /  arrow to toggle between ON and OFF.
4. Set the lower line to your desired selection and press the **ENTER**  button.
5. The top line will change to your new selection.





Note: If you press the left or right arrows before pressing ENTER to accept your new selection, your new selection will NOT be saved before changing to a different menu screen.

The **Max. Brake Limit** adjustment enables the driver to set the maximum trailer braking level just prior to trailer tire lock-up. For example, if a trailer starts to skid one or more tires at a level of 75% controller output, the **Max. Brake Limit** can be set to 70% and that will limit the automatic braking level of the DirecLink to 70%. All other brake scaling features operate as normal with the maximum auto braking limiting at 70%. However, the manual over-ride will always provide 100% trailer brake output when the trigger is pulled completely in, even when **Max. Brake Limit** is turned **ON**.

Once the **Max. Brake Limit** feature is turned ON as described earlier, the **Max. Brake Limit (% adjustment)** screen appears in the Main Menu sequence. To access the **Max. Brake Limit (% adjustment)** screen:

1. Press the **RIGHT ARROW**  key **TWO** (2) times from the **Brake Scale** (HOME) screen.

To change the value of the **Max. Brake Limit (% adjustment)**:

1. Press the **ENTER**  button and a number will appear underneath the current setting.
2. Press the **Up** or **Down**  /  arrow to increment the lower number up or down.
3. Set the lower number to your desired value and press the **ENTER**  button.
4. The top line will change to your new selected number.

**Note:** If you press the left or right arrows before pressing ENTER to accept your new selection, your new selection will NOT be saved before changing to a different menu screen.

---

# 9 Configure Option Menu





---

## 9.7 Controller Reset



The **Controller Reset** screen is where the driver can return all DireLink controller settings to the original manufacturer's defaults. This is helpful if the driver wants to reset and re-adjust the setting from the defaults that were in place when the DireLink was first installed into the vehicle.

In order to activate the **Controller Reset**:

1. Press the **ENTER**  button when on the **Controller Reset** screen.
2. An **ON** or **OFF** will appear underneath the current setting.
3. Press the **Up** or **Down**  /  arrow to toggle between **ON** and **OFF**.
4. Set the lower line to your desired selection and press the **ENTER**  button.
5. The top line will change to your new selection.



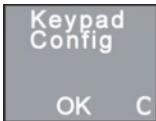

**Note:** If you press the left or right arrows before pressing **ENTER** to accept your new selection, your new selection will NOT be saved before changing to a different menu screen.

When **ON** is selected in the **Controller Reset** screen and the **ENTER** button is pressed, the screen will go to black and DireLink will re-start from the Vehicle Discovery process during which time all factory default settings will be restored. This means that any previously saved **Brake Scale** settings; **Low Speed Brake** settings and others will be lost and will need to be setup again.

## 9.8 Keypad Config Menu Options



The purpose of the Keypad Config menu is to adjust various settings of the DireLink as outlined below. To access the screens of the Keypad Config menu from the Configure Options menu:

1. Press the **ENTER**  button and the Controller Config screen will appear.
2. Press the **Up** or **Down**  /  arrow and the Keypad Config screen will appear.
3. Press the **ENTER**  button and the first of Keypad Config screens will appear: Scrn Bright.

There are two (2) screens that comprise the **Keypad Config** menu, they are:

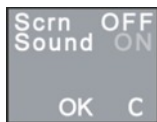
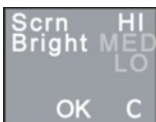

Pressing the up or down arrows will switch between these screens.

---





# 9 Configure Option Menu

---

## 9.9 Screen Brightness Adjustment





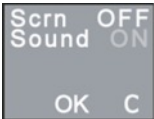

The Scrn Bright screen is used to adjust the brightness of the color display of the command module. There are three (3) settings which can be selected: 1) Hi, 2) Med, 3) Lo. Under various lighting conditions, you may wish to adjust the brightness of the display. To make adjustments from the Scrn Bright screen:

1. Press the **ENTER**  button which will select the current setting.
2. Press either the **Up** or **Down** / arrow until the setting you desire is highlighted.
3. Press the **ENTER**  button to select the new setting and the brightness level of the display will be changed to the level you have selected.

## 9.10 Screen Sound Adjustment



The Scrn Sound screen is used to enable or disable a beep sound when a keypad button is depressed. When enabled, a beep will be emitted each time a keypad button is successfully pressed. This sound can be used to provide feedback as you use the command module keypad. To enable or disable the keypad sound from the Scrn Sound screen:

1. Press the **ENTER**  button which will select the current setting.
2. Press either the **Up** or **Down** / arrow until the setting you desire is highlighted.
3. Press the **ENTER**  button to select the new setting and the sound will set according to your selection.

---

# 10 Monitor Options Menu



---

## 10.1 Monitor Options and Controller Data Screens



The purpose of the **Monitor Options** menu is to allow the driver to view key vehicle and controller parameters providing information on the operational status of the DireLink components and various network connections. The data that is displayed in the **Monitor Options** screen is able to be viewed only. None of the screens provide the ability to access or change the data.

To access the **Monitor Options** menu:

1. From the main menu, press and hold the **HOME**  button for 5 seconds.
2. After 5 seconds, the **Configure Options** screen will appear.
3. Press the **Up Arrow**  button and the **Monitor Options** screen will appear.
4. Press the **ENTER**  button and the first of the **Controller Data** menu will appear: **Vehicle Mode**.



There are four (4) screens that comprise the **Controller Data** menu, they are:



Pressing the Up or Down arrows will switch between these screens.

## 10.2 Vehicle Mode

The **Vehicle Mode** screen displays the status of the DireLink vehicle network connection. If the screen displays **Vehicle Mode** with a 4 character code (like PWM1), that indicates that the DireLink has successfully established and connected to your vehicle's network. If the screen displays Vehicle Search and a number is counting from 0 to 5, that indicates that the DireLink has not established a network connection with the vehicle and therefore is not operational.

## 10.3 Vehicle Battery and Brake Light Voltage

This screen displays the vehicle battery voltage monitored from the black wire of the Delphi harness. The brake light voltage displays the voltage level of the red wire on the Delphi harness.

## 10.4 Controller Temperature, Amps and Volts

The CTemp screen displays the temperature of the Control Module circuit board in degrees F. The CAmp displays the amperage output of the controller to the "blue wire" during normal braking or running the manual override. The CVIt displays the voltage output to the "blue wire" during normal braking or running the manual override.

---

# 10 Monitor Options Menu

---

## 10.5 MPH, KPH, RPM

The **MPH, KPH, RPM** screen displays those three parameters from the tow vehicle's network. The only time engine RPM is displayed is when velocity is zero. As soon as velocity is detected the engine RPM value disappears and only MPH and KPH are displayed. This screen is also used to indicate successful network communication between the DireLink and the tow vehicle.

---

# 11 Fault Codes and Trouble Shooting

---

## 11.1 When Faults Are Detected

The DirecLink automatically monitors many critical operational parameters. When a fault is detected, a RED screen will appear with a description of the fault and the module containing the fault. A "C" for Controller and a "K" for a Keypad fault will be displayed in the center of the bottom line of the screen. The RED screen will only appear if the Command Module is on one of the MAIN menu screens (Brake Scale, Low Speed Brake, Trans Temp.) The RED screen will be displayed for 3 seconds, disappear for 5 seconds and reappear for 3 seconds as long as the fault exists. The fault will be displayed continuously until the fault is cleared. If more than one fault is detected at the same time, the fault screens will cycle through the existing faults until they are corrected. If the Command Module is on a Config., Monitor or Fault menu screen when a fault is detected, the RED screen will NOT appear. However, the module containing the faults will be displayed in the center of the bottom line in red (C or K).

To clear a fault screen, the root cause of the fault must be corrected. To learn more about a fault, use the fault viewer menu as outlined in sections 11.3 and 11.4. The fault screens will provide information regarding the problems that need to be corrected. Section 11.5 provides a brief description of the main faults and methods of correcting them. The table below shows a summary of faults.

## 11.2 Fault Descriptions

Code Description	Additional Information
System OK	OK appears in center of bottom line
P3, P4, P5 Low Voltage	RJ connector low voltage
Blue Wire Short	Brake current/signal wire short
OBDII Low Voltage	OBDII or DB9 Disconnected
No OBDII Communication	
P3, P4, P5 Short	RJ connector Short
P3, P4, P5 Overcurrent	RJ connector Overcurrent
Control Module Overheating	
White Wire Ground Open	Ground wire on Delphi Disconnected
Black Low Voltage	Black wire on Delphi Disconnected

---

# 11 Fault Codes and Trouble Shooting

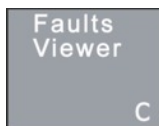

---

## 11.3 Fault Viewer Screens



The **Fault Viewer** menu allows the driver to view the details of the general faults that appear on one of the main menu screens as outlined in section 11.1 of this manual. When a fault appears on the screen, it may be necessary to get more information about the fault. This information is available in the **Fault Viewer** screen.

To access the **Fault Viewer** menu:

1. From the main menu, press and hold the **HOME**  button for 5 seconds.
2. After 5 seconds, the **Configure Options** screen will appear.
3. Press the **DOWN ARROW**  button and the Fault Viewer screen will appear.
4. Press the **ENTER**  button and the **Controller Faults** screen will appear.

There are two (2) screens that are accessible under the **Fault Viewer** menu:

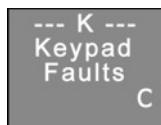

Pressing the Up or Down arrows will switch between these screens.

## 11.4 Select the Controller Fault Screen

Press the **ENTER**  button on the **Controller Faults** screen and if one or more faults exists with the Controller, the first fault in the list will appear:

If no faults are present, screen will read "NONE". If only one fault is active, it will be the only one on the screen. If more than one fault is active, the screen will cycle through the faults showing each one for 3 seconds. When the faults are corrected, they will not appear in the fault cycle.

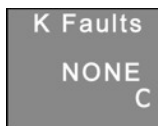







The DireLink continually monitors for the presence of faults so that when a fault is corrected, the DireLink removes it from the list. This means that the driver can have the specific fault displayed on the fault screen while making corrections and when the fault is corrected, it will disappear thereby giving confirmation to the driver that the fault is fixed.

The fault viewing process works the same for the "C" and "K" type faults.

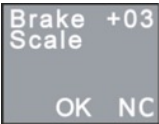

# 11 Fault Codes and Trouble Shooting

## 11.5 Descriptions of Major Faults and Resolutions

Fault Screen	Probable Cause of Faults and Trouble Shooting Methods
	<p>This screen indicates that the black wire (12V +) of the four wire Delphi connector (connector #4 as outlined on page 1 of this manual) is either not connected properly, has an intermittent connection or there is no power from the vehicle electrical system. This fault completely disables your trailer brake system.</p>
	<p>This screen indicates that the white wire [ground (-)] of the four wire Delphi connector (connector #4 as outlined on page 1 of this manual) is either not connected properly or has an intermittent connection. This wire is to be connected to the negative terminal of the tow vehicle battery only. This fault completely disables your trailer brake system.</p>
	<p>This screen indicates that the blue wire trailer brake voltage or signal wire of the four wire Delphi connector (connector #4 as outlined on page 1 of this manual) is shorted to ground. This fault completely disables your trailer brake system.</p>
	<p>This screen indicates that the connection between the DirecLink and the OBDII connector is loose or disconnected. These are connections 3 with 4 or connections 4 with 7 as outlined on page 3 of this manual. Tightening or reconnecting the cables should resolve this problem. This fault results in the DirecLink operating in emergency mode as indicated by a "red" braking bar while vehicle braking.</p>
	<p>If the trailer connector is properly plugged into the tow vehicle's trailer wiring receptacle and the screen still displays a red NC, check the following; 1) The display to determine if any faults are indicated. 2) Verify that the wiring of the trailer connector and the tow vehicle receptacle absolutely correspond by wire function (NOT BY WIRE COLOR) 3) Ensure that the connector plug and receptacle are clean and free of corrosion. 4) Use the Monitor Menu to verify all electrical connections (including the Brake Light voltage) and verify the brake controller output in voltage and amps. 5) If the trailer braking system is electric drum brakes, ensure the trailer brake magnet ground is properly connected per the manufacturer's instructions.</p>
	<p>The DirecLink screen is dark/not functioning. There are three potential causes: 1) The vehicle is turned off and the DirecLink is asleep. Press the brake pedal to wake it up. 2) The spiral cable (cable #5 as outlined on page 1 of this manual) is not properly connected to either the control module or the command module which results in a lack of electrical power to the command module. If the spiral cable is properly connected, unplug it from the control module and re-plug it into one of the other two connectors on the front of the control module. If this does not resolve the problem, the cable might need to be replaced. To isolate the problem to the command module, check the LEDs on the front of the control module. If the PWR LED is solid green and the S-1 LED is flashing green, then the control module has power and is functioning properly. 3) If the LEDs on the front of the control module are not functioning as outlined above, this verifies that there is no power on either the OBDII connector or the Delphi connector. You must restore power to resolve this problem. If the "red" LED is flashing on the control module, there most likely is a wiring problem with the spiral cable or possibly with the wiring to the control module.</p>

# 12 DirecLink Menu Navigation Overview

## 12.1 Menu Structure Overview - Menu Levels

Following a successful First Time Power-up which is outlined in Section 3.4 of this manual, the screen displayed on the Command Module will be the Brake Scale screen shown below.

Brake	+10
Scale	
OK	C

This is the "Home Screen". Whenever you press the Home button on the Command Module, you will return to this screen.

### There are four (4) menu levels of the DirecLink.

#### The Top Level:

Brake	+10
Scale	
OK	C

Low	+3
Speed	
Brake	
OK	C

If turned "ON"

Max.	100%
Brake	
Limit	
OK	C

If available

TransTemp	
185F	
OK	C

To navigate between the screens of the top level shown above, use the right arrow button on the Command Module to move forward through the screens or the left arrow button to navigate backward to previous screens.

To navigate down to the Level 1 Menu shown below, hold the home button down for 5 seconds which will take you to the Configure Option screen below left.

#### Level 1 Menu: Settings and Diagnostics

Configure	
Options	
OK	C

Monitor	
Options	
OK	C

Fault	
Viewer	
OK	C

To navigate between the screens of the Level 1 Menu, use the up or down arrow buttons.

To navigate down to the Level 2 Menu shown below, use the Enter button to select one of the Level 1 Menu options. This will take you down to the screen immediately below it.

#### Level 2 Menu:

Controller	Keypad	Controller	---C---	---K---
Config.	Config.	Data	Controller	Keypad
			Faults	Faults
OK	OK	OK	OK	OK
C	C	C	C	C

To navigate down to the Level 3 Menu shown below, use the Enter button to select one of the Level 2 Menu options. This will take you down to the screen immediately below it.

#### Level 3 Menu:

Trair	LRG	Scrn	HI	Vehicle	C	K
Size		Bright		Search	Faults	Faults
				0	None	None
OK	OK	OK	OK	OK	OK	OK
C	C	C	C	C	C	C

---

# Limited Warranty

---

## **DirecLink Warranty**

Tuson RV Brakes, LLC (hereafter referred to as Tuson) warrants the DirecLink trailer brake controller to be free of defects in material and workmanship, under normal use, for a period of five (5) years from the original consumer purchase date. At Tuson's sole option, Tuson will repair or replace the defective product with a like product. Replacement product or parts may include remanufactured or refurbished parts or components. This warranty applies only to the first consumer purchaser, is nontransferable, and is limited to components supplied with the DirecLink trailer brake controller product. The purchase or use of the DirecLink trailer brake controller constitutes acceptance of the conditions stated in this document. Tuson makes no guarantee, warranty, or representation regarding the suitability or legality of this product. It is the consumer's responsibility to ensure regulatory compliance before purchasing or using this product. The consumer agrees to operate this product in keeping with all laws governing its use. Under no conditions will Tuson be responsible for anything other than the repair or replacement of the original product.

## **Limitation of Liability and Warranty Exclusions**

Tuson's liability is limited to the cost of repair or replacement of the DirecLink trailer brake controller. This limited warranty excludes, but is not limited to damage, deterioration, or malfunction due to negligence, abuse, accident, improper use, misuse, improper installation, failure to follow supplied instructions, alteration, modification, unauthorized repair or attempted repair, external causes, normal wear and tear, or any other cause which does not relate to a product defect. This limited warranty also excludes any incidental, consequential, or other claims, damages, or losses, even if advised of the possibility of such, including against the consumer by any other party. There are no other warranties, express or implied, including implied warranty of merchantability and fitness for a particular purpose. All disputes will be handled in accordance with Illinois state laws.

For assistance with your DirecLink trailer brake controller, please call 800-968-8766.

For more information about DirecLink, visit our website at [www.direclink.com](http://www.direclink.com)