

# RF WIRELESS CAMERA SYSTEM



## INSTALLATION AND USER GUIDE

RFCAM 1000  
RFCAM1200A  
RFCAM1200B

## RF Wireless Backup Camera System

**Tuson** RV Brakes' RF Wireless Camera System is specially designed with multiple camera inputs to allow drivers to add different views: Hitch View, Backup View, or Side View together or individually. Our "Hitch View Wireless Camera" design allows you to connect or disconnect trailers safer and easier by significantly reducing blind spots. Our RF Wireless Backup Camera System allows you to monitor your trailer while you are towing in real time.

### Product Features:

- Easy installation.
- Views can be switched freely on the 7" large display.
- RF wireless camera system has long range transition and built in LED visual light to allow user turn on or off for viewing in low light conditions.
- Wireless camera uses digital wireless and anti-hopping technology (Signal interference immunity and image stabilization).
- Sharp, clear with no lag image.

### 7" LARGE LCD DISPLAY

The 7" color wireless monitor is easily installed using a suction cup mounting that attaches to your windshield and a power cord that plugs into the 12 Volt DC accessory power of your vehicle."

### RF WIRELESS BACKUP CAMERA WITH AUDIO

"RF Wireless Backup Camera" System allows you allows you to see and hear behind your trailer while you are backing--up or towing in real time.

### HITCH VIEW CAMERA VIDEO ONLY

"Hitch View Wireless Camera" design allows you to connect or disconnect trailers safer and easier by significantly reducing blind spots.

Please read this manual thoroughly before installing your new RF wireless camera system.



**WARNING**

Failure to heed important instructions below can result in death or serious injury.

**WHEN INSTALLING THE CAMERA OR WHEN CHECKING IF IT IS INSTALLED SECURELY, DO SO AFTER PARKING THE VEHICLE IN A SAFE PLACE AND ON AN EVEN LEVEL BY TURNING OFF THE ENGINE AND APPLYING THE PARKING BRAKE.**

Failure to do so may result in an accident.

**THE DRIVER MUST VISUALLY CHECK BEHIND AND AROUND THE VEHICLE WHEN PUT IN REVERSE.**

The rear view camera assists the driver in checking conditions behind the vehicle. The camera uses a wide-angle lens; therefore, the actual distance is shorter than in what appears on the screen.

## **1. Safety Information**

### **USE ONLY IN VEHICLE WITH A 12 VOLT NEGATIVE GROUND.**

Check with your dealer if you are unsure. Failure to do so may result in fire, etc.

### **BEFORE WIRING, DISCONNECT THE CABLE FROM THE NEGATIVE BATTERY TERMINAL.**

Failure to do so may result in electric shock or injury caused by electrical shortages.

### **DO NOT DISASSEMBLE OR ALTER ANY PARTS OF**

Doing so may result in an accident, fire or electrical shock.

### **KEEP SMALL OBJECTS SUCH AS SCREWS OUT OF REACH FROM CHILDREN.**

Swallowing them may result in serious injury. If swallowed, consult a physician immediately.

### **DO NOT USE BOLTS OR NUTS IN THE BRAKE OR STEERING SYSTEMS TO MAKE GROUND CONNECTIONS.**

Bolts or nuts used for the brake or steering systems (or any other safety-related system), or tanks should NEVER be used for installation or ground connections. Using such parts could disable control of the vehicle and result in fire, etc.

### **WHEN USING A DRILL TO MAKE A HOLE, TAKE PRECAUTIONS BY WEARING GOGGLES TO AVOID FRAGMENTS FROM INJURING THE EYES.**

Failure to do so may result in injury.

### **DO NOT DAMAGE PIPE OR WIRING WHEN DRILLING HOLES.**

When drilling holes in the chassis for installation, take precautions so as not to contact, damage or obstruct pipes, fuel lines, tanks or electrical wiring. Failure to take such precautions may cause fire.

### **MAKE THE CORRECT CONNECTIONS.**

Failure to make the proper connections may result in fire or product damage.

### **HAVE THE WIRING AND INSTALLATION DONE BY EXPERTS.**

The wiring and installation of this apparatus requires specific technical skills. To ensure safety, always contact an experienced or professional mechanic to have the work done.

### **STOP USE IMMEDIATELY IF A PROBLEM APPEARS.**

Failure to do so may cause personal injury or damage to the product. Return it to your authorized dealer or to the nearest Service Center for repair.

### **USE SPECIFIED ACCESSORY PARTS AND INSTALL THEM SECURELY.**

Be sure to use only the specified accessory parts. Use of other than designated parts may damage this apparatus internally or may not securely install the apparatus in place. This may cause parts to become loose, resulting in product failure and safety hazard.

### **DO NOT ATTACH THE CAMERA MOUNTING BRACKET TO FLUOROCARBON RESIN FINISHED VEHICLE BODIES OR GLASS.**

Doing so could weaken the adhesive strength between the bracket and the mounting surface and cause the bracket to fall off, resulting in accidents, injury or damage to the vehicle body.

### **DO NOT ATTACH THE CAMERA MOUNTING BRACKET TO ANY SURFACE WHERE THE ENTIRE ADHESIVE SURFACE CANNOT BE APPLIED.**

Doing so could weaken the adhesive strength between the bracket and the mounting surface and cause the bracket to fall off, resulting in accidents, injury or damage to the vehicle.

## **2. Kit Contents**

|                             | <b>RFCAM1000</b> | <b>RFCAM1200A</b> | <b>RFCAM1200B</b> |
|-----------------------------|------------------|-------------------|-------------------|
| <b>1 x 7" LCD Display</b>   | ✓                | ✓                 | ✓                 |
| <b>1 x Hitch Camera</b>     |                  | ✓                 |                   |
| <b>1 x RF BOX</b>           |                  | ✓                 |                   |
| <b>1 x Backup Camera #1</b> | ✓                | ✓                 | ✓                 |
| <b>1 x Backup Camera #2</b> |                  |                   | ✓                 |

### **Accessories in the box:**

- 1 x Cigarette Lighter Power Cable
- \*2 - 3 x Antenna
- \*2 - 4 x Mounting Screw
- 1 x Monitor Holder
- 1 x User Manual
- 1 x Warranty Card

\*Note the Qty of antennas and mounting screws depended on the number of cameras used.

### **3. Installation**

#### **Wireless Backup Camera Installation:**

##### **Mechanical Installation:**

Remove the plastic shrink wrap from the RF Wireless Backup Camera. Attach the provided antenna to the RF Wireless Camera by screwing it in place using only your fingers to tighten in place. Select the appropriate mounting location for your camera. To obtain the best camera performance we recommend that the RF Wireless Backup Camera be mounted as high on the rear end of the trailer or vehicle as possible to do so. The antenna of the backup camera should be above the top of the trailer or vehicle if possible to do so for best performance.

Another consideration is the location of 12 VDC power required to operate the camera. We recommend that the camera be centered in the trailer for best backup viewing. One option you may have would be to locate the backup camera near the center trailer running lights. Once you have selected the best mounting location, remove the two (2) Phillips head machine screws from the backup camera. Once removed the sunscreen, camera and mounting base are now loose. Keep the two (2) Phillips head screws for reassembly of the camera.

Fasten the camera mounting bracket to the trailer mounting location using at least two (2) mounting screws and washers (mounting screws and washers not included.) The RF Wireless Camera can be damaged or destroyed if not securely fastened to your vehicle! Tuson Corporation assumes no responsibility for damage as a result of and improper installation. Once the mounting bracket is securely mounted to the trailer, reassemble the camera and sunscreen to the mounting bracket using the two (2) Phillips head machine screws. Tightening these two Phillips screws will fix the camera viewing angle in the vertical and fix the position of the sunscreen simultaneously. Tighten these two (2) Phillips screws fully to lock the RF Wireless camera into the



mounting bracket.

**In order to get better wireless transmission between camera and display, place camera as high as possible. It is suggested the camera's antenna be over the roof.**

##### **Electrical Installation:**

The RF Wireless Backup camera has a bonded pair of 14 AWG lead wires colored red positive (+) and black ground (-). Connect the positive red camera lead wire to the 12 VDC power circuit positive wire (+) using a weather proof electric connector. Next connect the black lead ground (-) wire from the camera to the ground circuit (-) wire using the weather proof electric connector provided.

#### **Wireless Backup Camera**

Red wire: +12 voltage. Black wire: Ground.

**Hitch View Camera Installation:**

**Mechanical Installation:**

**Step 1 - Wired Camera**

The Tuson RF Wireless Hitch View System is made up of two parts the Wired Camera and the RF Transmitter. Select the mounting location of your wired camera. We recommend that the camera be placed just above your rear license plate centered just above the hitch location for bumper pull trailers. For other types of hitches 5th Wheel, Goose Neck applications you will need to determine the best mounting location for viewing your hitch with the Wired Camera. Prepare the Wired Camera mounting surface with isopropyl alcohol to clean the surface completely. Mount the camera once the surface is dry by removing the release paper on the camera adhesive and pressing the base of the Wired Camera firmly in place. Once the Wired Camera is mounted the RF Transmitter must be installed.

**Step 2 - RF Transmitter**

Screw on the loose antenna onto the brass coaxial connector on the RF Transmitter. Select a mounting location for the RF Transmitter. The RF Transmitter can be mounted behind the tail light assembly in some vehicles. Mounting the RF Transmitter behind the tail lights in your vehicle will give you access to you backup light circuit of your vehicle. Be sure to secure the RF Transmitter to a convenient mounting surface on your vehicle using screws or plastic zip ties. The RF Transmitter can be damaged if not securely fastened to your vehicle.

**Electrical Installation:**

**Step 1 - Wired Camera**

Attach the male black plastic molded connector from the Wired Camera to the female black plastic molded connector which is the video/power wiring harness. This harness has the female black plastic molded connector leading to the yellow male video connector and the red/black 14 AWG bonded pair power lead wires, black ground (-) and red positive (+).

**Step 2 - RF Transmitter and Wired Camera**

Locate the 12 VDC vehicle power wires for the RF Transmitter and Wired Camera. If installation is going to be behind the tail light locate the reverse light circuit lead wires. Attach the positive (+) lead wires from the Wired

Camera and RF Transmitter harness and connect to the positive (+) lead wire of your vehicle's reverse light circuit. Next attach the ground wire (-) lead wires from the Wired Camera and RF Transmitter to the ground (-) lead wires of the reverse light circuit on your vehicle. Please note that if the reverse light circuit of your vehicle is used as described above the camera will only work when the reverse light circuit is active when you put your vehicle into reverse. If you would like your hitch view camera system to work all of the time you will need to identify an alternate 12 VDC power circuit source on your vehicle to supply

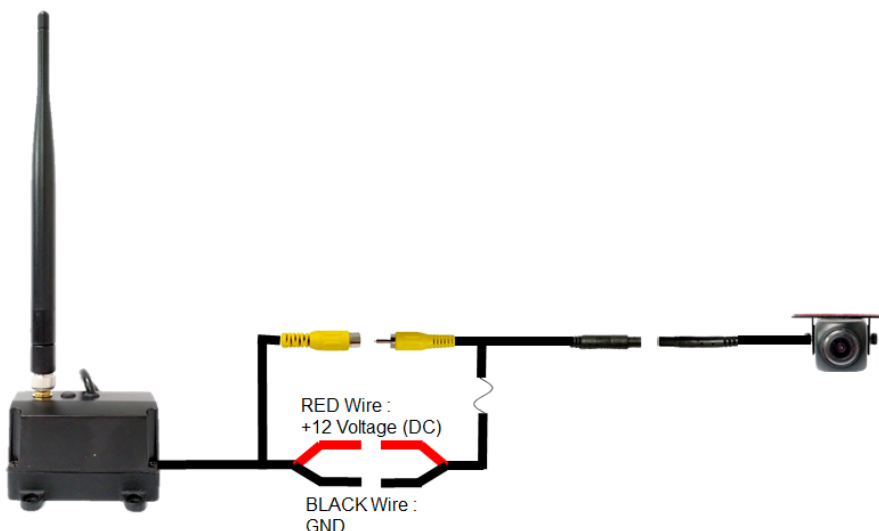



continuous power for the hitch view camera.

**Hitch camera with RF Box (Only for RFCAM 1200A)**

Red wire: +12 voltage. Black wire: Ground.

**4. Wireless Monitor Operation**



|   |   |           |   |
|---|---|-----------|---|
| 1 |  | Power     | System power On/Off   |
| 2 | MOD   | MOD       | CH1 or CH2 selection  |
| 3 |  | Enter     | OSD functions : Volume(NC),<br>Brightness, Contrast Color, Line,<br>Default |
| 4 | >   | Right     | On OSD operation : select forward.<br>Guideline display off.                |
| 5 | <   | Left      | On OSD operation : select backward.<br>Guideline display on.                |
| 6 | LED   | LED light | Power on indicator.   |

**On OSD mode:**

With the Guideline display off on the monitor, Press  Enter key to display OSD functions on the monitor. The OSD functions are Volume (NC) 、Brightness 、Contrast 、Color 、Line (NC) 、Default. Use > Right key or < Left key to increase and decrease the value for each OSD function when selected.

OSD functions:

1. Volume : adjust speaker volume.
2. Brightness : adjust screen brightness.
3. Contrast : adjust screen contrast.
4. Color : adjust screen color.
5. Light : Wireless backup camera LED light On or Off.
6. Default : Reset manufacture setting value.

**Guideline:**

The Guideline #1 is available for CH1 and Guideline #2 is available for CH2.

Press Left key to display the guideline and press Right to off the guideline from the screen.

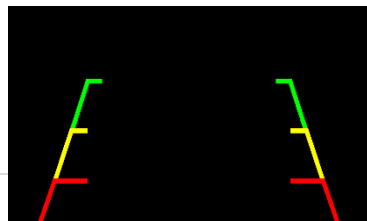

**Guideline #1**

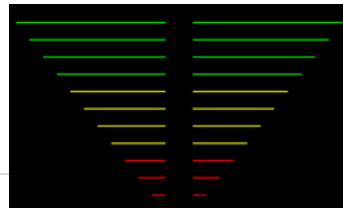

**Guideline #2**



➤ Guideline #1 adjustment:

- Press  $\leftarrow$  Enter key to select three types of guideline.

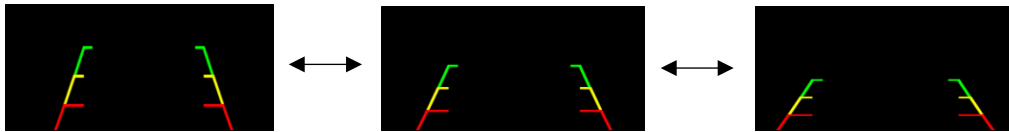

- Press < Left key to move the guideline.

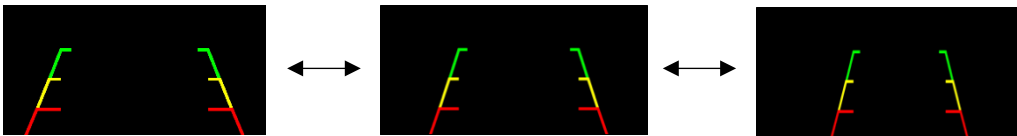

**Wireless backup camera LED light On/Off**

The wireless backup camera equips LED light and user can turn the LED light on or off from the monitor by following below steps:

1. On the guideline, press Right key to off the guideline.
2. On the off guideline, press Right to turn on or off the wireless backup camera LED light.

**Pairing the wireless monitor with the wireless camera**

The system is paired and ready to operation. In some cases user can repair the monitor and cameras by following below steps:

1. Press the pair bottom on the back of the monitor for 5 seconds. The monitor will display "PAIRING START". The pairing time will be 60 seconds.
2. During the pairing time, press the pairing bottom on the camera until the monitor display "SAVE DATA".
3. After pairing success, the camera image will display on the monitor.

**Troubleshooting:**

- **NO SIGNAL:** The monitor did not receive any data from camera. Please check the camera power or repair the system.

## RF WIRELESS CAMERA SYSTEM INSTALLATION AND USER GUIDE

- Wait CH1 signal: Please check the camera's power is on or repair the system.
- Wait CH2 signal: Please check the camera's power is on or repair the system.

## **5. Specification**

| Parameter                 | Specifications                                       | Unit               |
|---------------------------|--|--------------------|
| Monitor Scene Size        | 7 inch digital LCD monitor                           | inch               |
| Supply Voltage            | DC+9.0~16V   | V                  |
| Operation Temperature     | -30 ~ +85 / -22 ~ +185                               | °C/°F              |
| Storage Temperature       | -40 ~ +85 / -40 ~ +185                               | °C/°F              |
| Luminance                 | 320~400  | cd/ m <sup>2</sup> |
| Contrast Ratio (CR)       | 400~500  |                    |
| Video type                | Auto : NTSC/PAL 1Vp-p/75                             | Ω                  |
| Work Current              | 5  | A                  |
| RF operation frequency    | 2.402~2.495  | GHz                |
| Ratio protocol            | Proprietary FHSS                                     |                    |
| TX RF output power        | 18   | dBm                |
| RX sensitivity            | -86  | dBm                |
| Video decoder             | H.263  |                    |
| CCD Operation Temperature | -20 ~ +70 / -4 ~ +158                                | °C/°F              |
| CCD Storage Temperature   | -30 ~ +80 / -22 ~ +176                               | °C/°F              |
| CCD Resolution            | 600 TV lines   |                    |
| CCD Sensor                | CMOS Image Sensor                                    |                    |
| CCD Lens Angle            | 100°(H) 70°(V)                                       |                    |
| CCD Exposure Control      | AES(auto electric shutter),<br>1/60 ~ 1/100,000 sec. |                    |
| CCD White Balance         | Auto   |                    |
| CCD Gain Control          | Auto   |                    |
| CCD Gain Control          | Auto   |                    |
| Waterproof                | IP67   |                    |

## **6. Customer Service**

All product support and warranty coverage is provided by the distributor that your product was purchased in. Please contact with your distributor who originally sold you your RFCAM product.

Or contact us:

[www.direclink.com](http://www.direclink.com)



## RF WIRELESS CAMERA SYSTEM INSTALLATION AND USER GUIDE

Tuson RV Brakes, LLC  
475 Bunker Court  
Vernon Hills, IL 60061  
800-968-8766

### Limited Warranty

Tuson RV Brakes, LLC (Tuson) warrants the Tuson Wireless backup camera system (RFCAM) to be free of defects in material and workmanship for a period not to exceed One (1) years from the date of sale to the original consumer, or to the first retail purchaser of a trailer on which the TSC is installed. Original receipt(s) or other acceptable proof of purchase should be retained by the customer for verification of warranty date. THIS WARRANTY IS NOT TRANSFERABLE.

Tuson's obligations under this warranty shall be limited to crediting the account of a direct buying distributor or OEM trailer manufacturer, replacing or repairing the TSC products which are determined by Tuson to be defective in material or workmanship, within 60 days of receipt of such product by Tuson. Tuson reserves the right to request the product be returned intact, freight prepaid, PRIOR to processing any claim for warranty.

Warranty claim must be received by Tuson within 30 days of the discovery of the alleged defect, or within 30 days of the expiration of the warranty, whichever is earlier. Covered repairs or replacements will be made at Tuson's expense. Shipment of replacement product or repaired product by Tuson will be via best available ground shipment carrier. Shipments other than by best available ground shipment carrier, must be requested in writing and must be paid for in advance by the customer. Returned product that is found not to be defective, will be returned at senders expense.

This Warranty shall not include any products which have been improperly installed, installed contrary to installation instructions provided with the product, altered, tampered with or changed in any way, or utilized in a manner not approved by Tuson. This Warranty shall not extend to any defects arising from abuse, misuse, accident, improper wiring, or negligence of the installer or the consumer.

EXCEPT AS EXPRESSLY SET FORTH ABOVE, NO OTHER WARRANTY, EXPRESS OR IMPLIED, AT LAW OR IN EQUITY, IS MADE BY TUSON CORPORATION IN RESPECT OF THE PRODUCT, INCLUDING WITHOUT LIMITATION ANY IMPLIED WARRANTY OF MERCHANTABILITY, FITNESS FOR A PARTICULAR PURPOSE OR ANY OTHER WARRANTY, AND ANY SUCH WARRANTIES ARE EXPRESSLY DISCLAIMED.

IN NO EVENT SHALL TUSON BE LIABLE TO PURCHASER OR ANY THIRD PARTY FOR ANY LOST PROFITS, CONSEQUENTIAL, EXEMPLARY, INDIRECT, PUNITIVE, INCIDENTAL, OR SPECIAL DAMAGES OR COSTS (INCLUDING ATTORNEY FEES), OR LOSS OF GOOD WILL RESULTING FROM ANY CLAIM (INCLUDING BUT NOT LIMITED TO ANY CAUSE OF ACTION SOUNDING IN CONTRACT, TORT, NEGLIGENCE, STRICT LIABILITY OR PRODUCT LIABILITY) REGARDING THIS AGREEMENT, EVEN IF THE COMPANY HAS BEEN ADVISED OF THE POSSIBILITY OF SUCH DAMAGES.

Some states do not allow the exclusion or limitation of implied warranties, incidental or consequential damages, so the above limitations or exclusions may not apply to you. This Warranty gives you specific rights. You may have other rights, which vary from state to state.